

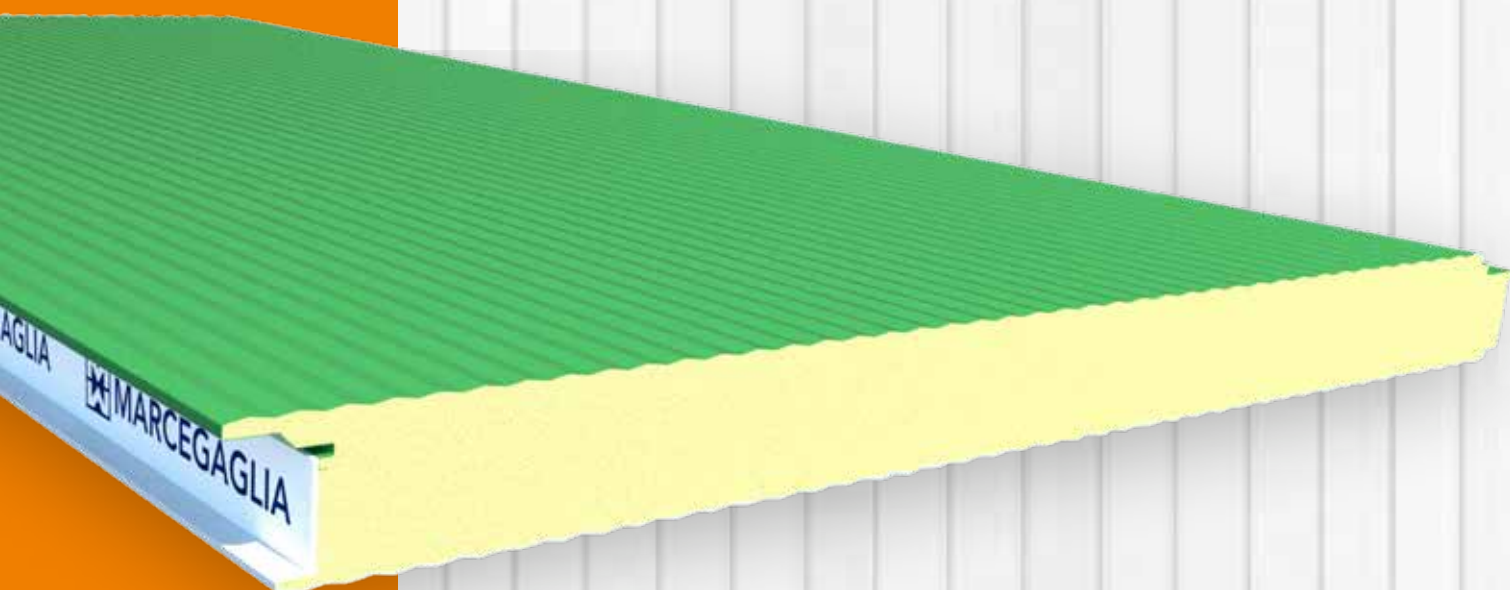

 **MARCEGAGLIA**
BUILDTTECH

Product datasheet
and instruction for use

MB HIDDEN FIX





**INFORMATIVE
NOTE**

The technical documentation and suggestions contained in this manual are the best understanding of the company regarding the properties and uses of the products and are intended to support the work of installers and technicians operating in the metal construction sector by providing useful information and suggestions concerning use.

However, given many possibilities of use and the possibility of interference from external elements, the company assumes no responsibility for possible results. It is the responsibility of the user to ascertain the suitability of the product for the intended use, assuming responsibility for any consequential damage.

The user is also required to know procedures necessary for the installation of products, including the preparation of **safety plans** and the updated requirements of all current regulations, in order to avoid dangerous situations.

Values indicated in **the capacity charts** are the result of practical tests carried out in our laboratories and certification bodies; however, the verification of the same, depending on the application, is the responsibility of the design engineer.

For any further information or clarification, please contact the Marcegaglia Buildtech technical office at the addresses listed on the back.

TABLE OF CONTENTS

MB HIDDEN FIX	2
Product typology	2
Joint typology.....	3
Technical specifications	4
Metal supports	5
Protection of supports.....	5
Panels weight.....	5
Thermal trasmittance.....	5
Static characteristics.....	6
Fire behaviour.....	7
Advice and instructions for use.....	8
Thermal expansion	8
Useful design information	9
Transport, storage and handling.....	10
Transport and standard composition of packages.....	10
RULES FOR MATERIALS HANDLING, STORAGE AND INSTALLATION	11
Installation instructions	13
Fixing system	13
Installation and equipment.....	14
Vertical Installation.....	15
Horizontal installation	16
Examples of solutions for the installation of wall panels	17
Maintenance and disposal	20
Routine maintenance	20
Disposal.....	20
Safety data	21

The dissemination and copying of this document are prohibited - art. 1175 and 2015 of the Italian Civil code.
Any violations will lead to a criminal prosecution as per art. 646 of the Italian Penal code.

MB HIDDEN FIX

Sandwich panels with polyurethane insulation and concealed fixing joint, used for the construction of walls of high aesthetic value intended for indoor and outdoor environments.

Product typology

Ribbed wall panels with concealed fixing - PDF

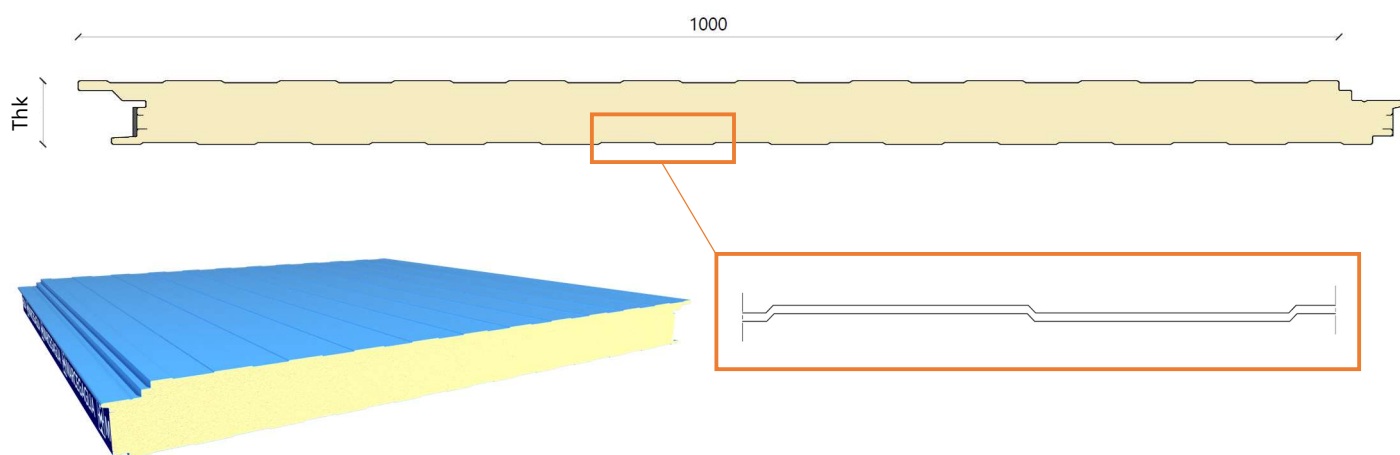

Micro-ribbed wall panels with concealed fixing - PSF

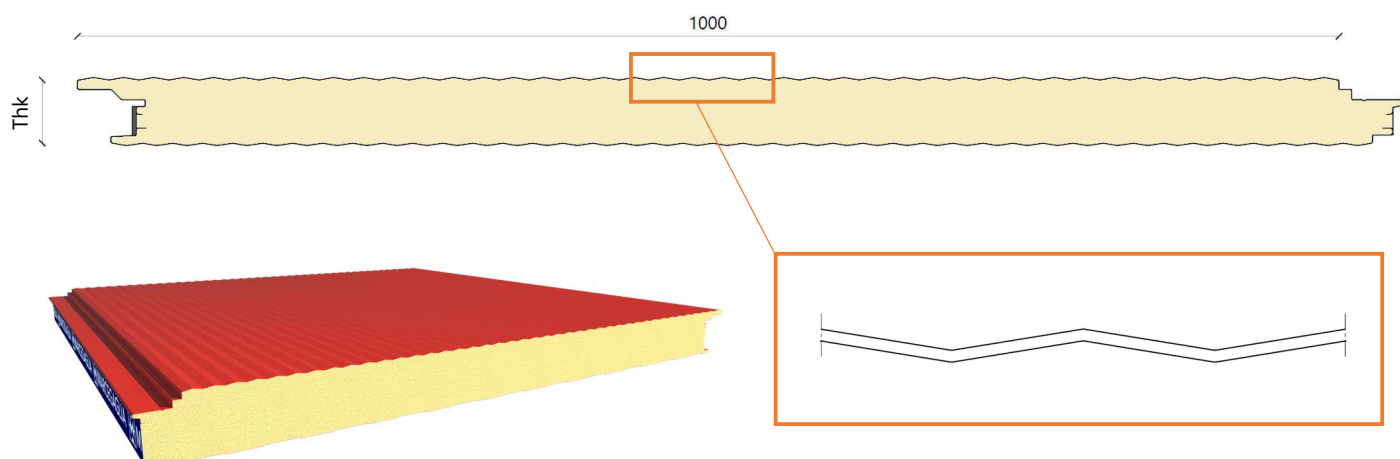

Flat wall panels with concealed fixing - PLF

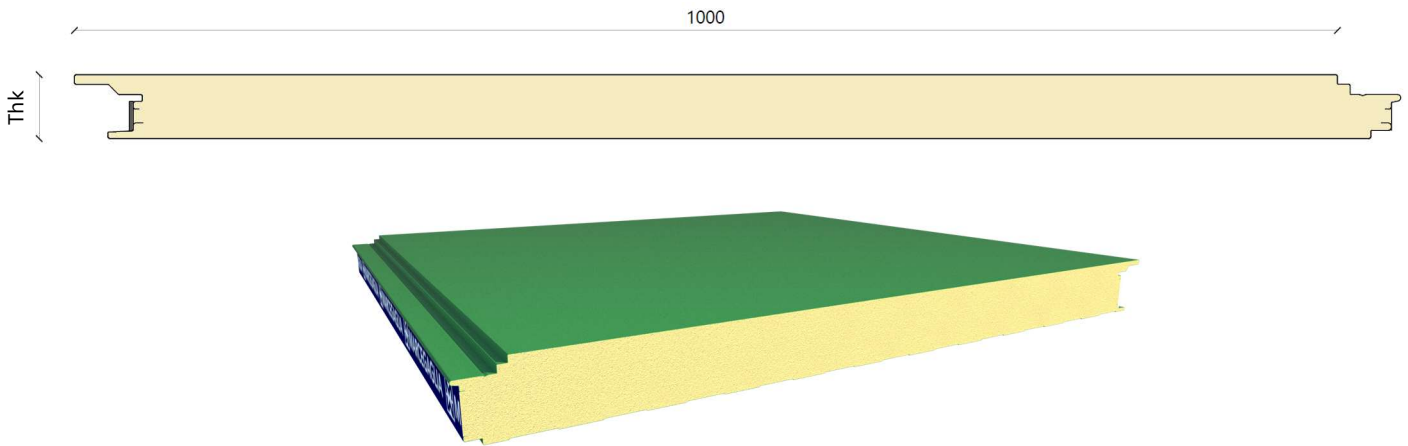

Joint typology

REINFORCEMENT PLATE

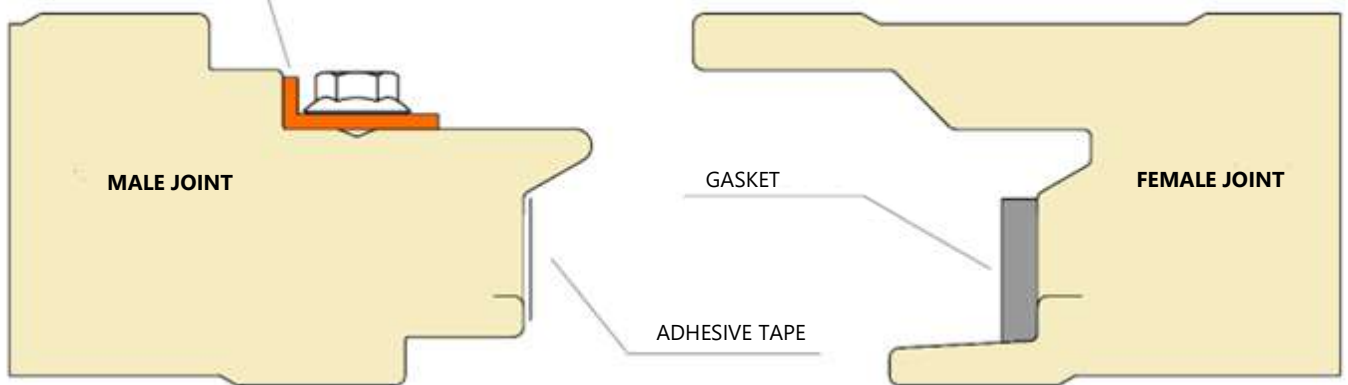

GROUT 0÷3 mm*

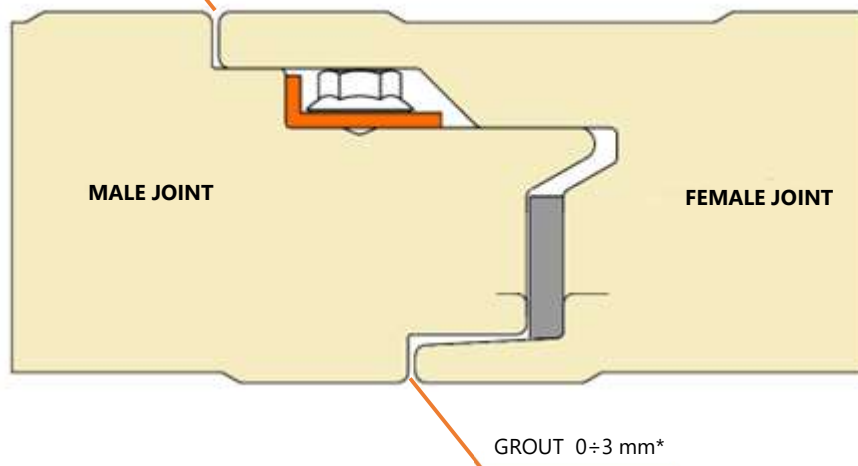

* Several dimensional variables intervene during the production phase for which this gap may be greater than the theoretical value and therefore may not constitute a functional defect of the product or be subject to non-conformity.

Thanks to its shape, the concealed fixing joint designed by Marcegaglia Buildtech allows the creation of walls with a high aesthetic value combined with the typical functionality of MB's products.

The gasket inserted during production helps improving the hermeticity of the joint.

An empty space is formed on the external side of the panel in correspondence of the joint which is necessary for the housing of the selected fastening system, and therefore it is not due to imperfections of the panel, but it is linked to its functional design.

Technical specifications

	MB HIDDEN FIX
Useful width	1000 mm
Length	Variable according to construction needs related to the dimensions of the roofs to be made. Maximum productive length 15 m. Standard transport limits 13.5 m.
	50 / 60 / 80 / 100 / 120 /150
Panel thickness	CFC and HCFC-free polyurethane formulations are used which produce anisotropic and anti-mould insulating foams with high content of closed cells (>95%) . Particularly high-performance fire reaction foams can be used for fire performance requirements.
Insulation	38 kg/m ³ ± 10%
Total average density	$\lambda = 0,022 \text{ W/mK}$
Tolerances <i>From UNI EN 14509</i>	<p>Panel thickness: ± 2 mm if ≤ 100 mm; ± 2 % if > 100 mm</p> <p>Panel length: ± 5 mm if L ≤ 3 m, ± 10 mm if L > 3 m</p> <p>Panel width (pitch): ± 3 mm</p> <p>Deviation from straightness: ≤ 1 mm per meter, ≤ 5 mm</p> <p>Deviation from flatness: ≤ 1.5 mm for L >700 mm</p> <p>Deviation from squareness: ≤ 0,60% of panel nominal width</p>
	Slight spills of foam coming out from joints and any minor faults or irregularities in the position of gaskets are considered normal.

Metal supports

Marcegaglia Buildtech offers the following metal support variants in the panels configuration:

Pre-painted steel, in accordance with EN 10169 (coil coating) based on EURONORMS:

- for standard production:
 - with MP3 polyester coating
- for special production:
 - with modified MP5 polyester coating
 - with MP10 polyvinylidene coating
 - with MP20 polyurethane / polyamide coating.

Plasticized galvanized steel EN 10346

Natural aluminium, pre-painted EN 485-2, EN 573-3, EN 11396.

Protection of supports

To prevent pre-painted metal supports from being damaged during the production and subsequent movement of panels, a polyethylene adhesive film is used which must be removed during the installation phase or in any case not later than 30 days from the production of panels.

Please note that it is highly recommended not to store panels in a place with prolonged sun exposure.

Marcegaglia Buildtech strongly advises against the request for material without a polyethylene adhesive film and assumes no responsibility for any damage in the event that such a request is submitted.

Panels weight

The average weight reported here is a purely indicative value.

STEEL

Supports thk. [mm]	Weight per panel thickness [kg / m ²]					
	50	60	80	100	120	150
0,50 / 0,50	10,25	10,60	11,40	12,15	12,90	
0,60 / 0,60	12,00	12,40	13,15	13,90	14,70	15,80

ALUMINIUM

Supports thk. [mm]	Weight per panel thickness [kg / m ²]				
	50	60	80	100	120
0,60 / 0,60	5,40	5,70	6,50	7,30	8,00

Thermal trasmittance

Panel thk [mm]	Thermal trasmittance [W/m ² K]					
	50	60	80	100	120	150
U (EN 14509)	0,54	0,42	0,29	0,22	0,18	0,14

Static characteristics

Capacity values in the charts below refer to panels subject to a distributed load that verifies the resistance to wind action, but they do not take into account thermal effects that must be considered by the designer. Concerned data are therefore indicative and **cannot replace design calculations** drawn-up by an expert and qualified technician who must verify and validate these indications taking into account the regulations in force at the place of installation. The number and layout of fastening systems must be defined by the designer.

The mechanical performance shown in the table has to be considered valid only under **positive pressure** wind action conditions, with a minimum useful width of the supports of 120 mm, so the action of depression/suction loads should be evaluated case-by-case.

For further details and information, please contact the Marcegaglia Buildtech Technical Office.

MB HIDDEN FIX PANEL STEEL												
Panel thickness	Supports thickness	Uniformly distributed positive load in kN/m ² [1/200 span]										
		▲ ▲ SINGLE SPAN [m]					▲ ▲ ▲ ▲ MULTIPLE SPAN [m]					
mm	mm	2	2,5	3	3,5	4	2,5	3	3,5	4	4,5	5
50	0,50/0,50	2,25	1,75	1,30	0,88	0,65	2,55	1,79	1,34	0,95	0,65	0,50
	0,60/0,60	2,40	1,87	1,39	0,94	0,70	2,80	1,92	1,44	1,02	0,70	0,54
60	0,50/0,50	2,70	2,20	1,70	1,20	0,90	3,20	2,30	1,80	1,30	0,80	0,60
	0,60/0,60	2,90	2,40	1,82	1,28	0,96	3,38	2,48	1,93	1,39	0,86	0,64
80	0,50/0,50	3,50	2,50	1,90	1,50	1,20	4,35	3,25	2,42	1,85	1,40	1,15
	0,60/0,60	3,70	2,70	2,10	1,61	1,28	4,50	3,45	2,60	1,98	1,50	1,23
100	0,50/0,50	3,78	2,78	2,18	1,78	1,48	4,83	3,73	2,90	2,33	1,88	1,63
	0,60/0,60	3,98	2,98	2,38	1,89	1,56	4,98	3,93	3,08	2,46	1,98	1,71
120	0,50/0,50	4,16	3,06	2,40	1,96	1,63	5,31	4,10	3,19	2,56	2,07	1,79
	0,60/0,60	4,38	3,28	2,62	2,08	1,72	5,48	4,32	3,39	2,71	2,18	1,88
150	0,60/0,60	4,82	3,61	2,88	2,29	1,90	6,03	4,75	3,73	2,99	2,40	2,07

MB HIDDEN FIX PANEL ALUMINIUM												
Panel thickness	Supports thickness	Uniformly distributed positive load in kN/m ² [1/200 span]										
		▲ ▲ SINGLE SPAN [m]					▲ ▲ ▲ ▲ MULTIPLE SPAN [m]					
mm	mm	2	2,5	3	3,5	4	2,5	3	3,5	4	4,5	5
50	0,60/0,60	1,65	1,00	0,60			1,50	1,00	0,62			
60	0,60/0,60	1,80	1,25	0,80	0,40		1,80	1,30	0,90	0,60		
80	0,60/0,60	2,15	1,66	1,20	0,80	0,58	2,00	1,60	1,20	0,90	0,63	0,40
100	0,60/0,60	2,48	1,98	1,53	1,13	0,91	2,33	1,92	1,53	1,23	0,98	0,80
120	0,60/0,60	2,73	2,20	1,68	1,24	1,00	2,56	2,10	1,68	1,35	1,10	0,90

Fire behaviour

Reaction to fire

Indicates the degree of participation of a material in the fire to which it is subjected.

The European standard **UNI EN 13501-1** of 2009 regulates the reaction to fire classification of construction products and elements by defining:

- 7 **Euroclasses** that indicate the contribution to fire of products in an increasing manner, from class A1 for non-combustible products, to class F for products that are not tested or classified.
- 3 classes for **smoke** emission:
 - **s1** smoke absent
 - **s2** low emission of smoke
 - **s3** high emission of smoke
- 3 classes for **dripping**:
 - **d0** absence of flaming particles
 - **d1** low presence of flaming particles
 - **d2** high presence of flaming particles (drips)

MB HIDDEN FIX panels can reach the Bs1d0 fire performance level under certain configuration conditions agreed upon with the technical and commercial office. The declaration concerning the performance degree will only be issued under these conditions.

Please note that the mechanical, reaction and resistance performance to fire and behaviour to fire on roofs must be requested and agreed upon in advance when purchasing the material.

Unless specifically requested, product supplied will have no fire behaviour performance.

Advice and instructions for use

Thermal expansion

Sandwich panels, given the nature of materials they are made of, are subject to the natural phenomenon of thermal expansion in the presence of a thermal excursion acting on metal supports.

This phenomenon acts on the straightness of the panel causing bends and deformations that can affect the functionality and the aesthetic appearance in the event that proper precautions are not taken.

The following conditions may affect the deformation of panels:

- Significant lengths (e.g. ≥ 5 m)
- High solar radiation
- Dark supports colour ($R_G = 8-39$, EN 14509:2013)
- Supports material
- Support thickness
- Polyurethane foam insulation core, specifically polyisocyanurate foam

The following charts illustrate the linear thermal expansion coefficients of different metals used for supports.

material	Linear thermal expansion coefficient [$^{\circ}\text{C}^{-1}$]
Steel	$12,0 \times 10^{-6}$
Aluminium	$23,6 \times 10^{-6}$

Colour	Surface temperature [$^{\circ}\text{C}$]	
	Minimum	Maximum
Very light ($R_G = 75-90$)	-20	+55
Light ($R_G = 40-74$)	-20	+65
Dark ($R_G = 8-39$)	-20	+80

The system must absorb linear elongations of the support due to high surface temperatures.

In the event of thermal fluctuations that are repeated in short periods such as day-night or freeze-thaw fluctuations, tensions are generated on supports that can cause undulations, imperfections and in some cases even wrinkling phenomena.

Marcegaglia Buildtech recommends:

- Taking into account deformations due to the thermal expansion of materials during the design and selection of panels.
- Segmenting panels.
- Avoiding dark colours, especially with significant lengths.
- Choosing the thickness of metal faces in a manner appropriate to the use and calculated deformations.
- Determining adequate fastening systems to compensate for expansions.

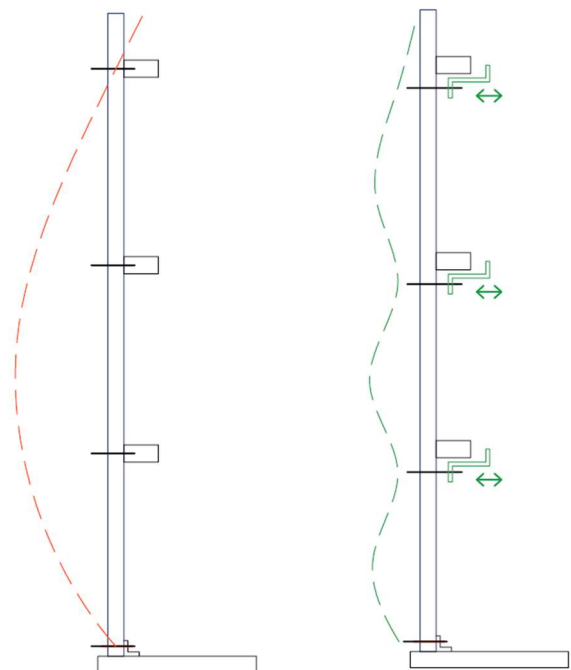

If the panel were fastened at the ends only, a curvature due to thermal expansions, such as the one shown in red in the figure, would occur. Normally, fastening systems provided for panels lead to a curvature similar to that shown in green.

Therefore it is advisable to assess whether it is necessary to use "mobile" fixing systems that can compensate for tensions due to expansion.

Useful design information

Marcegaglia Buildtech points out that it is necessary to dimension a load-bearing structure in the design phase that can absorb external load stresses so as not to jeopardize the basic functionality of panels due to excessive and permanent deformations.

The following environmental conditions must be taken into consideration during the design and selection of panels:

- **Thermal stress:** can lead to significant deformation of panels and depends mainly on the exposure of the building and on the colour of the external metal support.
- **Wind action:** exerts a loading pressure on exposed surfaces of the panel according to the wind speed, which varies according to the climatic zone in which the installation takes place. It is necessary to define the type and number of fixings according to the intensity of the described action.
- **Atmospheric aggressiveness:** it is necessary to choose the covering of supports suitable for the environment in which panels are installed (marine, industrial, urban, rural), since some environments are particularly aggressive in terms of corrosiveness of panel surfaces.

Note that the nature of metallic coatings in conditions of solar radiation permits the external surface temperature of the panel to reach very high temperatures (80 ÷ 90° C), with consequent possible bending and wrinkling of the sheet. Marcegaglia Buildtech, in order to limit the occurrence of such phenomena, recommends a choice of colours, lengths and thicknesses of metal supports that takes into account the conditions of the installation environment, preferably with light colours, limited lengths and supports with minimum thickness 0.60 mm.

If the possibility of using panels with an internal support different from the external one is taken into consideration, it is necessary to take into account possible deformations due to different coefficients of thermal expansion.

In particular environmental conditions, it is possible for condensation to form on internal surfaces of panels with consequent dripping inside the building; this phenomenon, if not addressed in a sufficiently short time, can promote the natural deterioration of the paintwork and supports. Therefore, Marcegaglia Buildtech recommends taking the described phenomenon into consideration during the design phase and possibly

performing a thermo-hygrometric check in order to choose the best solution.

Use of panels during the installation

During the installation, when panels are grabbed from packages, it is really important to consider the temperature that panels can reach because of the solar radiation on the exposed surface. Solar radiation bends the surface and complicates the installation, the matching and the pose of panels on the structure. For these reasons, Marcegaglia Buildtech suggests to put packages in a shaded area, at least the first panel on top, in order to avoid the direct exposure to the solar radiation during the installation.

During production, it is inevitable to use metal coils with imperceptible color differences due to the industrial production; for this reason, in order to avoid aesthetic differences and non-compliances, Marcegaglia Buildtech recommends to consider batches order and project references. In absence of references, it is recommended to install panels following packages numbers so as to use homogenous batches.

Marcegaglia Buildtech also recommends stocking spare panels beforehand (about 5% of the total), so as to make up for any lack of material due to damage during handling and installation.

IMPORTANT

When the product configuration varies, the technical characteristics and method of use may change. Therefore, Marcegaglia Buildtech recommends checking the suitability of the configuration and possible contraindications with the sales and technical departments.

Transport, storage and handling

Transport and standard composition of packages

Panels are supplied in a horizontal position, in storage packages that allow handling both by lifting straps and by fork lift trucks.

The standard number of panels contained within the single package varies according to the size and thickness of the panel (see chart).

Before proceeding with unloading and handling operations, it is advisable to check the weight of each package (variable according to panel lengths) and choose a lifting means of adequate lifting capacity.

The handling of loads and materials on site must always take place in compliance with the requirements of the safety regulations in force with the use of the appropriate personal protective equipment provided by the said regulations.

Thickness	Panels / package	Package height (including blocks)
mm		mm
50	15	836
60	13	866
80	9	806
100	7	786
120	6	806
150	5	836



RULES FOR MATERIALS HANDLING, STORAGE AND INSTALLATION

During the handling, storage and installation of materials, precautions must be taken to ensure the following:

- **protection of the surface from abrasion**, especially during handling;
- **protection against water stagnation or condensed moisture** that could lead to blistering;
- **protection** of the elements supporting the mass of the entire parcels, or of stacked parcels, **against permanent deformation**.

The best storage conditions for parcels are **indoors, with light ventilation, free of moisture and not dusty**. In any case, it is necessary to provide a suitable stable support surface that does not allow water to stagnate (**slight slope, minimum 5%**).

If storage is not followed shortly by removal for installation, it is a good idea to cover the parcels with protective tarpaulins suitable both for impermeability and internal ventilation.

Generally, parcels should not be stacked; if it is considered possible to do this, a **maximum of three parcels** may be **stacked**.

Parcels must not be placed in areas close to work (e.g. metal cutting, sandblasting, painting, welding, etc.) or in areas where transit or parking of operating vehicles may cause damage (impacts, splashes, exhaust gases, etc.).

If the materials are **covered with protective film**, this must be completely removed during assembly, but **preferably within 15 days and no later than 30 days from the date of "notice of ready goods"** and provided that the parcels are stored in a shady, covered, ventilated place protected from all types of weather. If materials are ordered, produced and delivered **without a protective film** on the painted substrate, **great care** must be **taken not to cause damage during handling and assembly**.

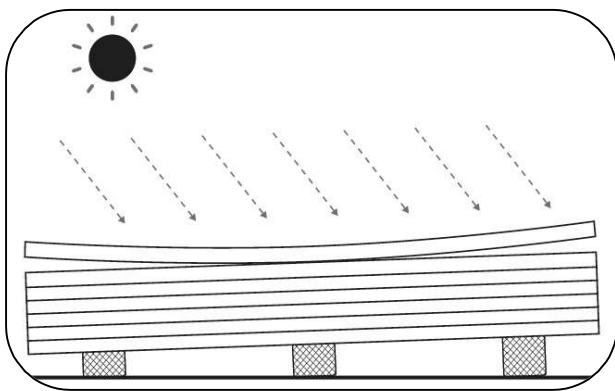
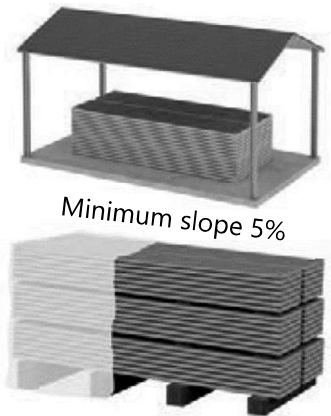

In order to maintain the original performance of the product, it is advisable, in accordance with these standards, **not to exceed six months** of continuous **storage in a closed and ventilated environment**, while storage in the **open air should never exceed two weeks**. The materials must **always be protected from direct sunlight**, as this can cause deterioration. During assembly, panels subjected to sunlight suffer a bowing that makes assembly difficult, so it is recommended to shade the parcel in use.



In the case of **transport in a container**, the products must be **removed from the container within 15 days from the date of shipment** in order to avoid deterioration of the pre-painted metal substrates due to the high concentration of moisture that can accumulate in the closed container for so long.

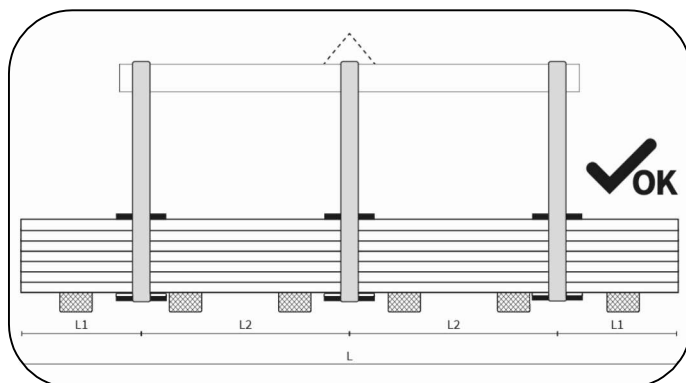

In handling, parcels must always be slinged at least two points not less than half the length of the parcels.

Lifting should preferably be carried out with **synthetic fibre (nylon) woven straps** with a width of no less than 10 cm so that the load on the strap is distributed and does not cause deformation.

Special **spacers** must be used below and above the parcel, consisting of sturdy flat elements of wood or rigid plastic material protected by softer material to prevent direct contact of the belts and damage to the panel in the parcel.

Gripping of parcels in the wrong manner such as using incorrect and/or incorrectly dimensioned gripping equipment or without considering the correct distance of the gripping points can lead to alterations and consequent damage to the panels in the parcel.

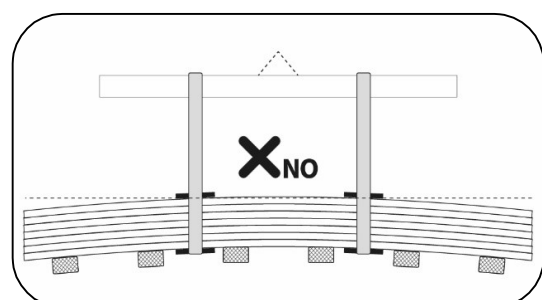
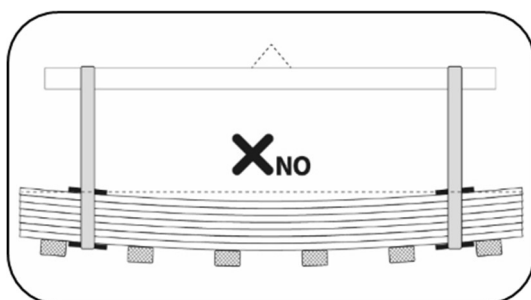

In the absence of a sling bar, in some cases unloading can also take place using suitable **forklift trucks**.

In order to avoid damage to the panel or even breakage of the parcel, the lifting equipment must have fork spacing and fork width **that take into account the parcel length, weight, and thickness of the panels** that affect the bending of the parcel.

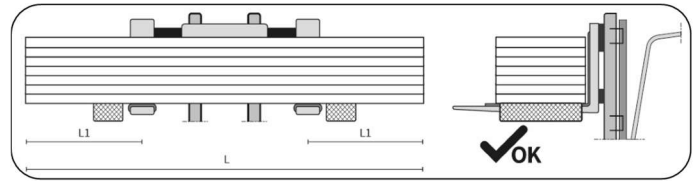

If the parcel is lifted in an unbalanced manner, not taking into account the correct gripping points, there is a risk of consequences such as the parcel falling or the panels being deformed and damaged.

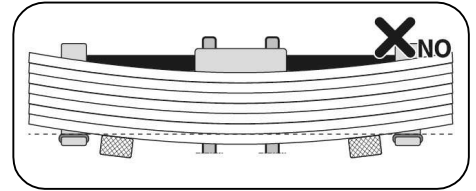
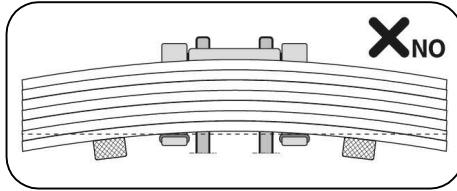
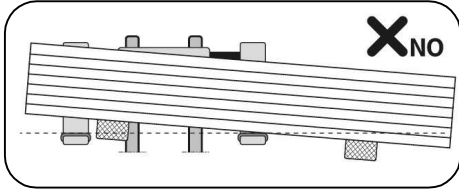

Handling of panels on site must be carried out with suitable **lifting systems** that have been **adequately designed and dimensioned** so as not to cause damage to the material during assembly.

Manual handling of the individual element must always be carried out by lifting the element itself **without sliding** it over the lower element and, if necessary, by rotating it by the side of the parcel, taking care not to damage the longitudinal joint of the panel; transport, if by hand, must be carried out by at least two persons depending on the length.

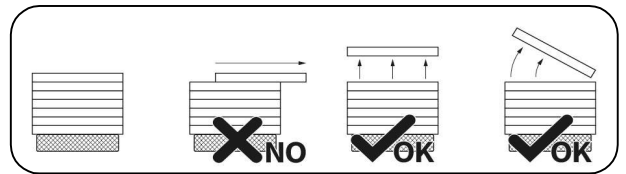

If necessary, depending on the size and weight of the individual panel, it is advisable to provide suitable mechanical lifting devices, such as **suction cup lifters** or special **grippers/jaw clamps**.

If suction cup systems are used, **an adequate distribution and number of suction cups** in relation to the surface area and weight of the panel must be provided; the system must be equipped with suction cups suitable for lifting sandwich panels, e.g. that can support the possibility of inserting **special pads** inside the suction cups to **prevent the metal support from detaching**. When present, the protective film on the metal support must be removed prior to the application of the suction pads, at least in the affected portion.

The study and analysis of the suction cup systems to be used is essential to avoid damaging the panels, so it is advisable to design suitable solutions by also discussing with the suppliers of the systems as experts in the field. **Failure to design the lifting system can lead to panel breakage as a result of panel imbalance.**

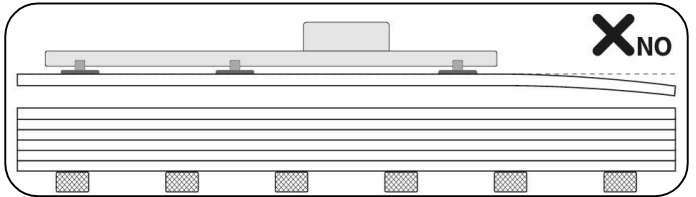
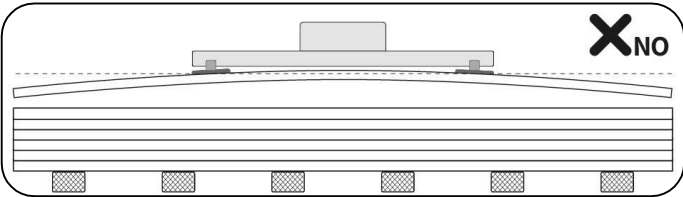
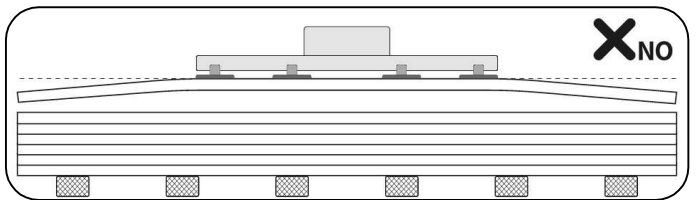
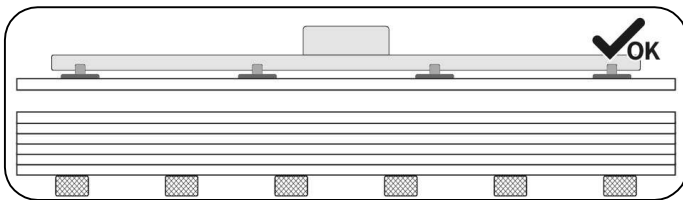

The following are, by way of example, two conceptual solutions for correct suction cup systems in which the suction cups are properly distributed according to the length of the panel.

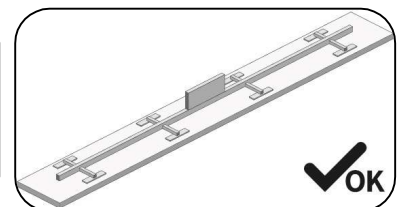
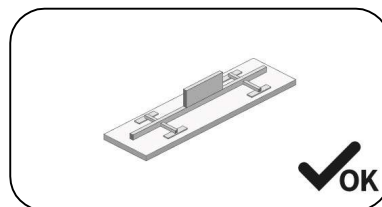

The panels must be installed by qualified personnel who are familiar with the rules of good engineering.

Instructions for use can be found in the product manuals that can be downloaded from our website www.marcegagliabuildtech.it under "catalogues and manuals". Personnel equipment, in particular all PPE, must be such as to ensure the safety of the worker and prevent damage to the panels during handling and installation.

WARRANTY Failure to comply with these minimum requirements shall exempt Marcegaglia Buildtech from any liability for damage to the products and the forfeiture of the warranty provided for in the terms and

Installation instructions

Fixing system

The most appropriate fixing system for the project must be established according to the type of installation, considering support structures (metal structural work) in order to guarantee safety, stability and leak-tightness.

Fixing elements must be able to withstand dynamic forces of stresses to which insulated panels are subjected (sudden changes in temperature, wind load, trampling, etc.) guaranteeing the mechanical sealing, load capacity and insulation .

The number and positioning of fixings varies according to the design and according to several variables, including local wind conditions, the distance between purlins and framework elements, and the height of the building.

There are two types of fixing:

- **Main structural anchors**

These fix the wall panel to the supporting structure and guarantee the anchoring, the mechanical resistance and the load capacity applied

- **Stitching**

Non-structural, they are functional for fixing the sheet metal, metal finishing elements and sheets of the panel to each other.

The fixing equipment is divided into:

- **Self-tapping screws (A)**

These are applied after having prepared the hole on the panel.

- **Self-drilling screws (B)**

These are applied directly without the preparation of holes using a screwdriver only.

- **Stitching screws (C)**

Smaller in size, they are used for the fastening of sheet metal elements and for stitching the overlap.

- **Reinforcing plates (D, E)**

Available in versions with one or two holes, allowing reinforcement and optimization of the fixing system.

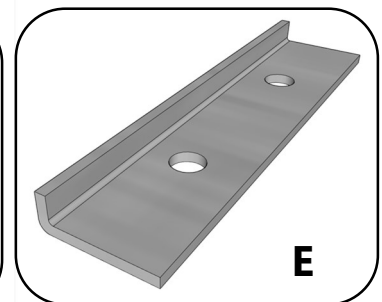
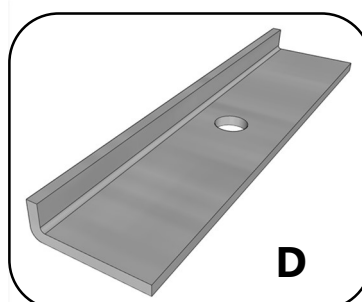
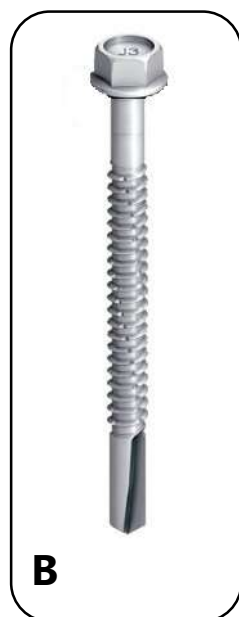
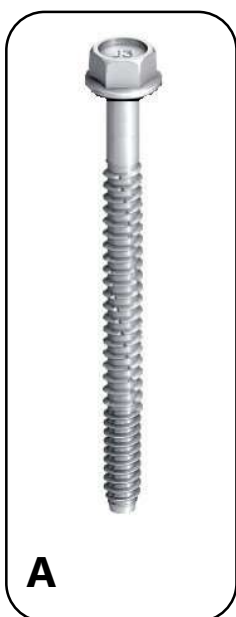

Installation and equipment

Preliminary operations:

- View project documents and follow relevant instructions.
- Check that the support structure is positioned correctly, does not present deformations or misalignments and is completely secured to the rest of the structure.
- Make sure that there is no interference with overhead power lines in the handling area of materials.
- Prepare appropriate accident prevention facilities according to the regulations in force for work at height.
- Check that all workers operating at height are equipped with appropriate personal accident prevention devices according to the regulations in force.
- Prepare power supply lines for the equipment used according to current regulations.
- Remove the protective film applied to pre-painted sheets over the entire length of the panel.

Installation equipment

The use of suitable tools and equipment in a suitable state of maintenance are required for the installation of insulated panels.

The following list shows, in a non-exhaustive manner, the equipment which is recommended for use and those the use of which must be strictly avoided.



PORTABLE DRILL
twist bit
max 8 mm Ø



SCREWDRIVER
with reverse function



JIGSAW



**VACUUM
CLEANER**



SHEARS
(right and left)



**ANGLE
GRINDER**



RIVETER
2,5-5 mm

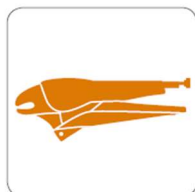

MOLE GRIPS



PLUMB LINE



**LASER
MEASURER**



SCRAPER



SPIRIT LEVEL



UNIVERSAL PLIERS



MALLET

Lifting with suction cups

If the suction cup lifting system is taken into consideration, the surface area of the suction cups must be appropriately dimensioned and the correct number of gripping points must be defined according to the length, thickness and weight of the panels. An improperly designed suction cup system can lead to deformation of the panel and detachment of the sheet from the insulation layer.

Vertical Installation

After installing the base flashing, identify the starting point for installing the first panel.

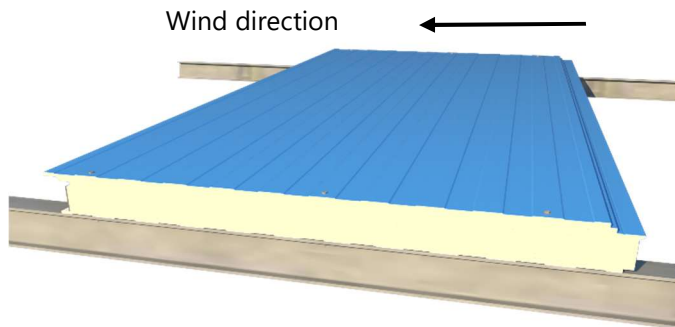

Fasten the panel along both ends to the steelwork on the rear with through-head screws and then the male joint, placing a steel reinforcing plate between the screws and the panel.

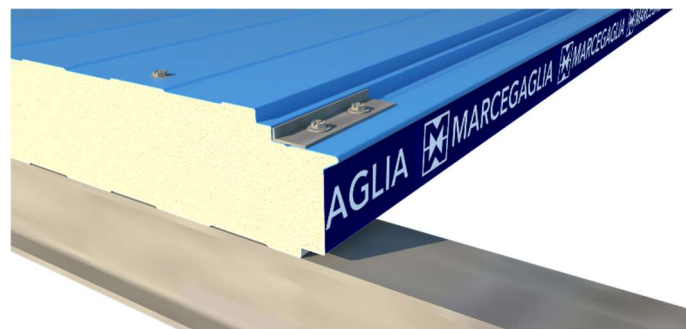

The table shows the recommended useful screw lengths depending on the thickness in mm of the wall panel to be installed.

Panel thickness	Minimum screw length
50	56 mm
60	66 mm
80	86 mm
100	106 mm
120	126 mm
150	156 mm

Before installing the next panel, check that the contact areas are clean and there are no residues or any smears of polyurethane foam.

Then install the second panel by engaging the female on the male of the first panel.

Check that the panels are fully aligned after engaging them and continue fixing in the same way as for the first panel.

In a similar way, proceed with the Installation of the subsequent panels until the end of the wall and complete the work with guttering to conceal the head-to-head areas of the panels and the fastening screws.

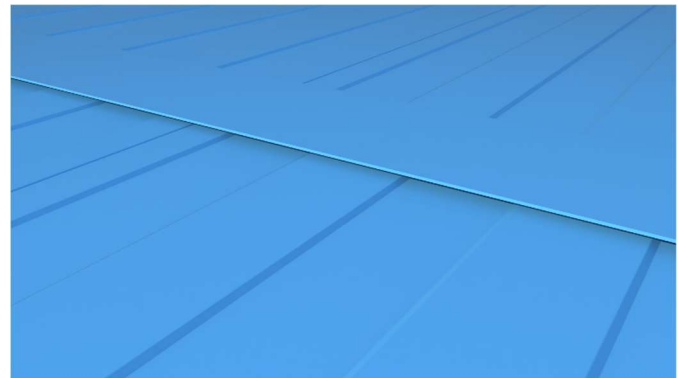
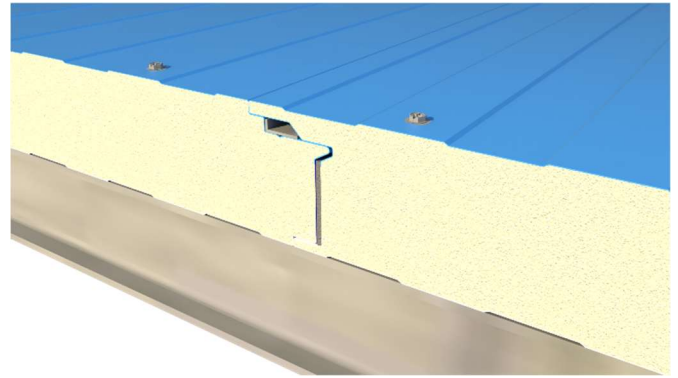
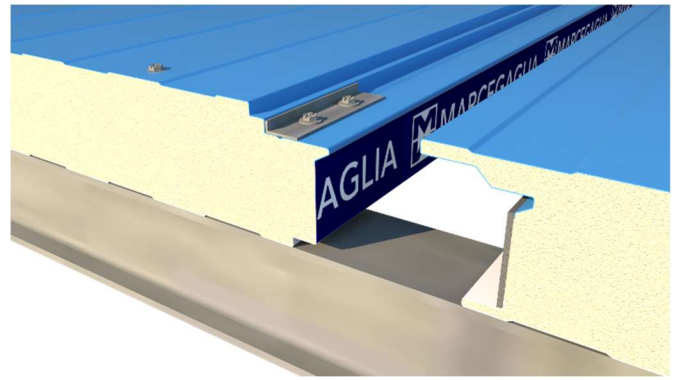

At the end of any cutting, drilling and fixing activities, ensure that **metal scraps are carefully removed** to ensure that surfaces remain clean.

Refer to the section *Examples of solutions for the assembly of concealed fastening wall panels* in the Technical Manual for the creation of wall corner joints, cutting doors and windows and other construction details.

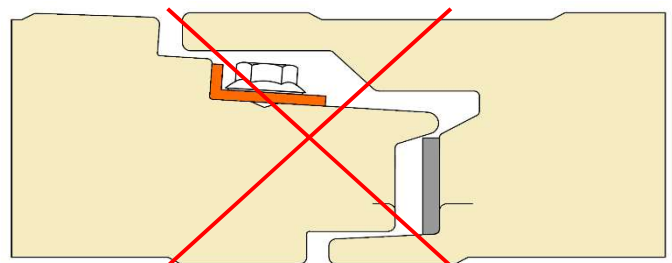

Pay close attention to the correct tightening of the screws, as over-tightening may deform the joint and cause imperfections.

Horizontal installation

For the horizontal installation of wall panels, it must be taken into account that the male-female joint was designed to guarantee the thermal insulation and watertightness properties along all junction lines between panels, whether in the case of outdoor applications (rainwater and humidity) or indoors (condensation, water vapour).

To guarantee these properties, take the utmost care during installation, always checking to ensure perfect horizontal positioning of panels. Furthermore, when they are overlapped they must be immediately tightened and fixed using screws at the points predetermined by the construction system.

Position the first panel with the male side facing upwards; this prevents rainwater and humidity from entering the joint from outside.

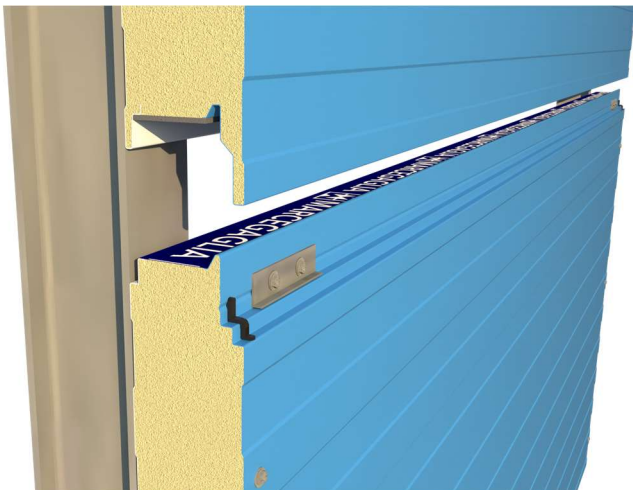
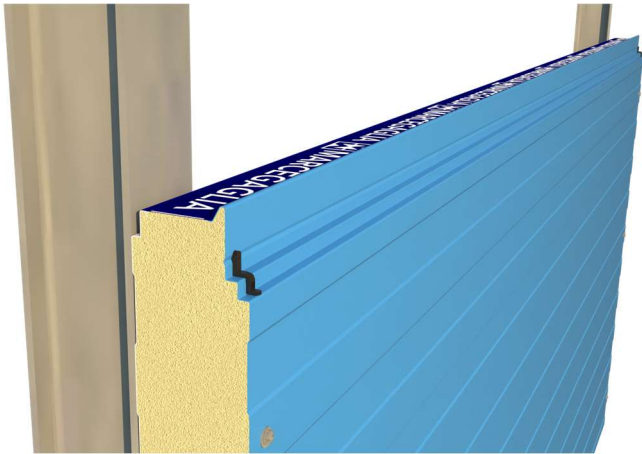

Check that the panel is perfectly horizontal and fasten it with through screws to the structural uprights along both ends of the panel and then near the male joint by placing a steel distribution plate between the screws and the panel. Screws must be of appropriate length (see section on vertical installation).

The position of fixings must always be such as to guarantee the resistance to stress, including uplift forces.

Before installing the next panel, check that the contact areas are clean and free of residues of polyurethane foam.

Position the second panel inserting the female part on the underlying male of the first panel.

Fix the second panel to structural uprights with appropriate screws in one of the two ways shown in the images below.

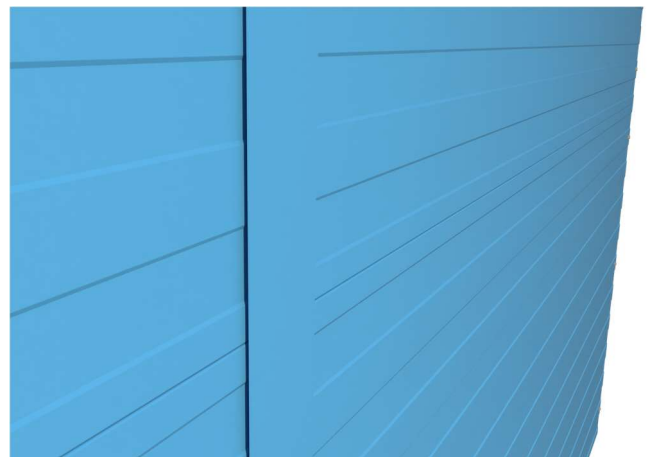
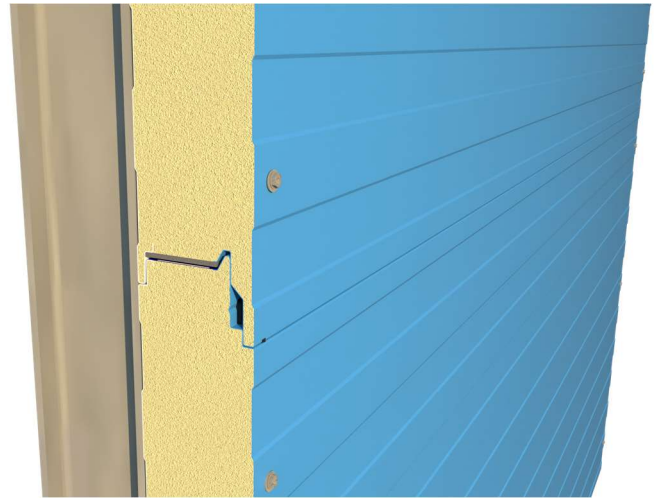

Similarly, proceed with the installation of the subsequent panels to the top of the wall.

Complete the work with guttering covering the head-to-head areas of the panels and the fixing screws.

Examples of solutions for the installation of wall panels

1a - Installation of wall panels on the plinth in a vertical position

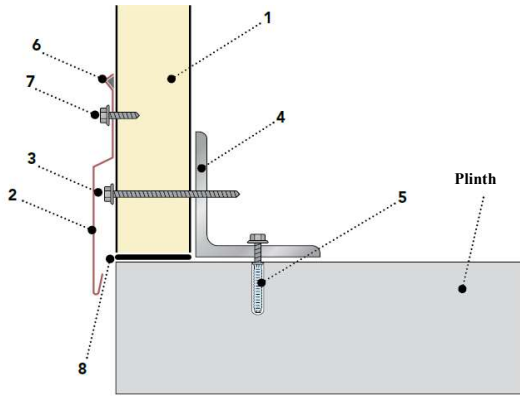

1	Wall panel
2	Flashing
3	Panel fixing screw
4	Steel angle according to the technical project
5	Anchor
6	Butyl seal mass
7	Sheet metalwork fixing screw
8	Basic gasket

1b - Installation of wall panels on the outside of the plinth in a vertical position

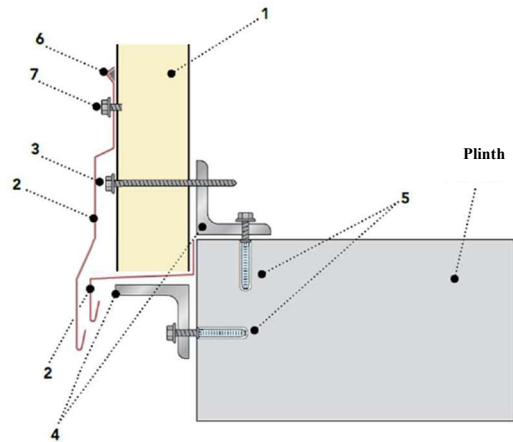

1	Wall panel
2	Flashing
3	Panel fixing screw
4	Steel angles according to the technical project
5	Anchors
6	Butyl seal mass
7	Sheet metalwork fixing screw

2 - Corner fittings

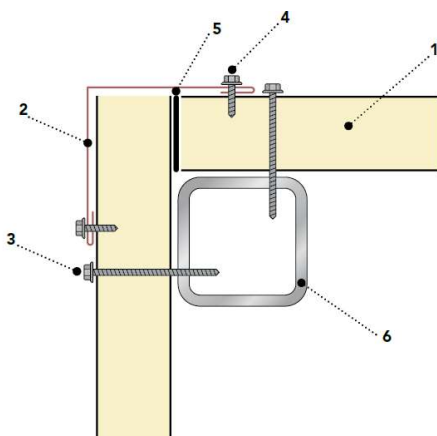
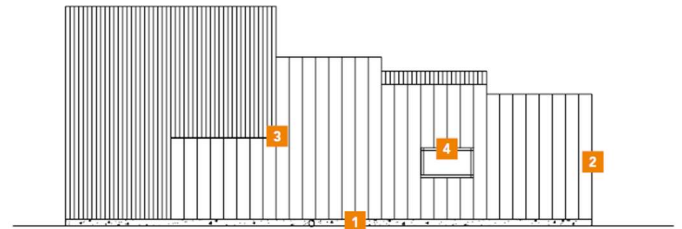

1	Wall panel
2	External corner flashing
3	Panel fixing screws
4	Sheet metalwork fixing screws
5	Flexible gasket (or polyurethane foam)
6	Structural steel tube according to the technical project



3a - Coupling between wall panels with vertical installation

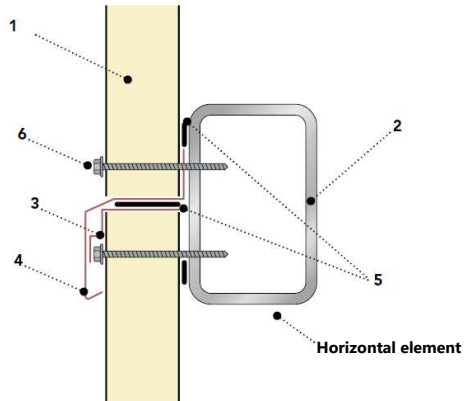

1	Wall panel
2	Structural steel tube according to the technical project
3	Support flashing
4	Joining sheet metalwork
5	Flexible gaskets
6	Panel fixing screws

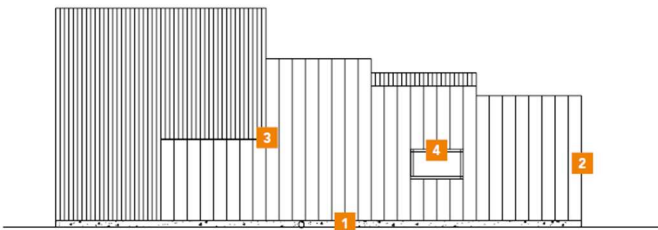

3b - Coupling between wall panels with horizontal installation

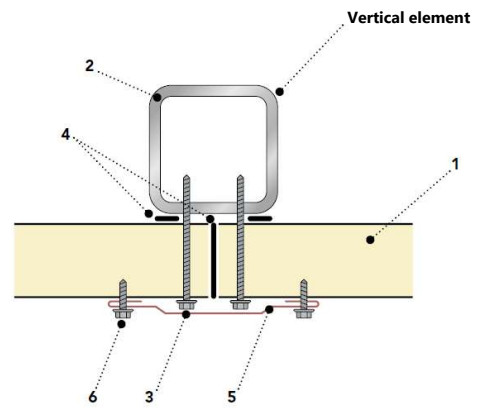

1	Wall panel
2	Structural steel tube according to the technical project
3	Panel fixing screws
4	Flexible gasket (or polyurethane foam)
5	Flashing
6	Sheet metalwork fixing screws

4a - Wall panel joining with window

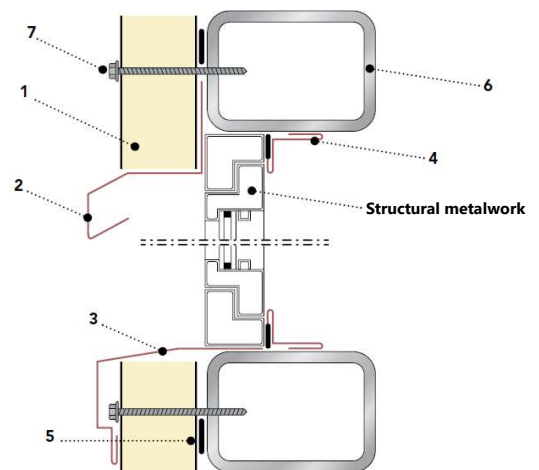

1	Wall panel
2	Protection sheet metalwork
3	Sill plate
4	Trimming
5	Flexible gasket
6	Structural steel tube according to the technical project
7	Panel fixing screws

4b - Wall panel joining with window

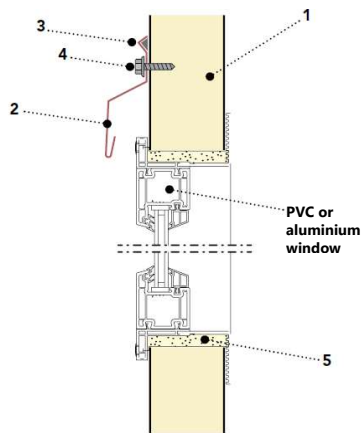

1	Wall panel
2	Flashing
3	Sealing compound e.g. butyl
4	Sheet metalwork fixing screw
5	Polyurethane foam

4c - Wall panel joining with window with internal frame

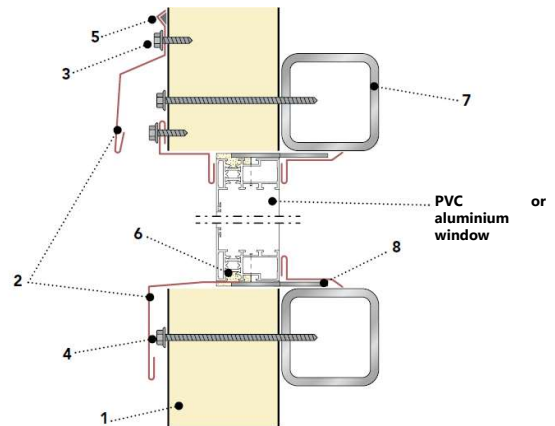

1	Wall panel
2	Flashing
3	Sheet metalwork fixing screws
4	Panel fixing screws
5	Sealing compound e.g. butyl
6	Polyurethane foam
7	Structural steel tubes according to the technical project
8	Steel bar welded to the bolt according to technical project

CUTTING EXAMPLE FOR WINDOW

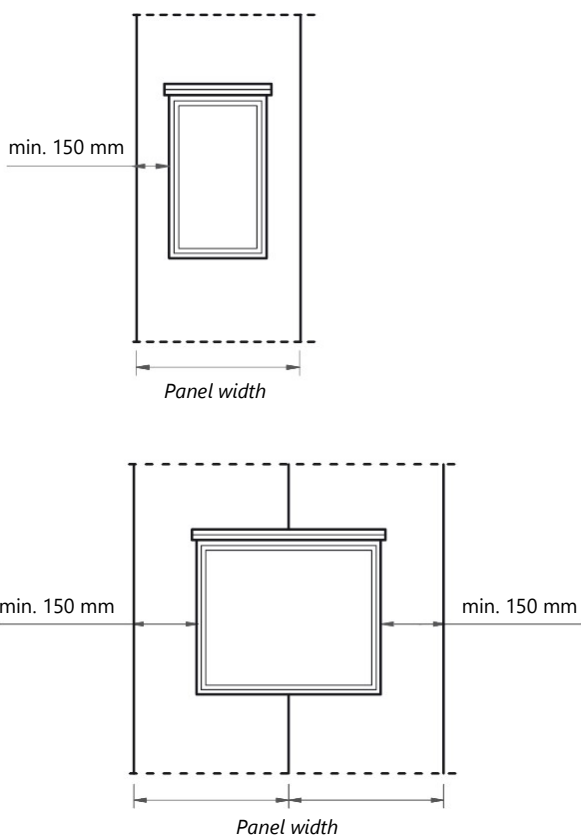

CUTTING EXAMPLE FOR DOOR

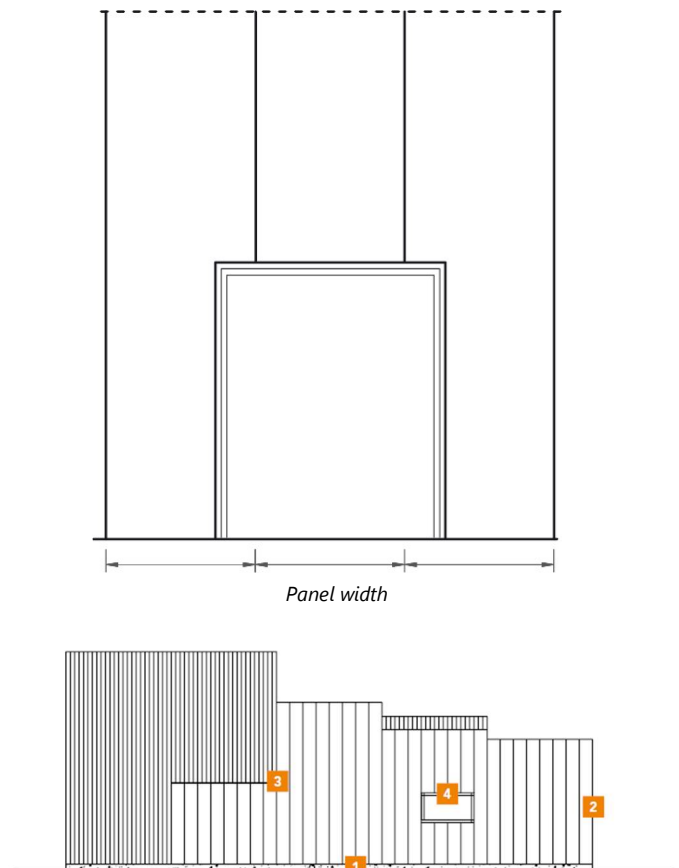

Maintenance and disposal

Routine maintenance

Routine maintenance is the responsibility of the end user and has the function of maintaining unchanged aesthetics and functionality of panels over years, following its construction.

The **periodic maintenance plan** must include the control:

- of **seals**, the deterioration and wear of which could cause a reduction in air and water tightness;
- of all the **fixings** to verify they are correctly tightened.

The following are the main causes of intervention and measures to be taken:

- **Storage of aggressive products:** pay particular attention to affected areas and perform a thorough cleaning.
- **Scratches or abrasions of pre-painted parts** caused by the transit of operators or accidental causes: eliminate by touching up the paint.
- **Loss of elastic or sealing properties of the seal** in joints of the sheet metalwork: restore the seal, after cleaning the pre-existing one.
- **Settling of structures and panels with loosening of fixing screws:** check and carefully tighten screws.
- **Dents caused by impacts:** in some cases it will be possible to intervene by restoring the surface; if this type of intervention is not feasible, the damaged panel must be replaced.
- **Formation of mould and algae**, possible in the case of environments with high humidity, in the shade or with stagnant water: moisten the area to be cleaned with cold water and then, using a non-abrasive brush, remove deposits with a very diluted solution of water, bleach and a cup of liquid soap. Rinse with clean water.
- **Deposits of salt**, for example in marine environments: in the case of light superficial incrustations, it is sufficient to use cold water through a garden hose at the standard pressure of the mains water supply. For all other cases, it is necessary to dampen the surface to be treated with cold water and then, using a non-abrasive brush, remove deposits with a very diluted solution of water, bleach and a cup of liquid soap. Rinse with clean water.

Failure to comply with these warnings, as well as the use of boiling water or abrasive material (brushes with metal bristles, etc.) can cause permanent damage to the surface, compromising the lifespan of product. For further information consult the technical information "Maintenance and restoration of pre-painted parts".

Disposal

The disposal of insulated panels must only be entrusted to authorized companies and carried out in compliance with the laws in force.



Safety data

Please note that the product to which this document refers is classified in accordance with the regulation (EC) 1907/06-REACH as an article without intentional release of chemical substances and as such does not require the preparation of a safety data sheet.

However, Marcegaglia Buildtech wishes to identify main dangers due to the use of the article in question.

1. Product identification

Insulated panel composed of two metal layers that contain a solid insulating layer of polyurethane foam.

Company / business identification

MARCEGAGLIA Buildtech S.r.l.

Via Bresciani 16 – 46040 – Gazoldo degli Ippoliti (MN) - IT

Phone +39.03766851

e-mail: tamponamento@marcegaglia.com

2. Dangers identification

The product does not pose dangers to human health under normal conditions of use in accordance with REG EC 1272/08.

3. Composition / information on ingredients

The product is composed of two pre-painted steel sheets containing an insulating layer of polyurethane foam.

Component	% in weight
Metal supports	47-63
Gaskets	≈1
Insulating material	36-52

4. First aid measures

The handling of the product without the appropriate PPE can cause injuries to the skin and eyes due to the presence of steel sheets; in the event of injuries contact a doctor immediately. In case of prolonged exposure to the dust, transport the affected person to a ventilated place.

5. Fire prevention measures

Polyurethane foam is non-flammable, but as an organic material it is combustible. However, the protection of metallic supports allows the risk of fire to be reduced to a low level.

The material used for packaging is combustible and if involved in a fire produces gases and fumes which could reduce visibility.

Extinguishing media

All extinguishing media are applicable. For large fires, use water, alcohol-resistant foams or universal foams according to manufacturer's instructions. For fires of limited proportion, use carbon dioxide or chemical powder.

6. Measures in case of accidental release

The product is stable; no special measures are expected to be taken.

In the event of accidental release of polyurethane dusts (coming, for example, from cutting operations), remove the material preferably with suction systems, ventilate the room and keep away from sources of ignition. Perform these operations with a protective mask.

7. Handling and storage

Handle using the appropriate personal protective equipment. For more information about handling and the personal protective equipment to be used, see section 8. For correct handling and correct storage, refer to the "Regulations for handling and storage of materials" in the technical manual.

8. Personal protection

Respiratory protection

Normal use does not require any protection for the respiratory tract. If it is necessary for work activities to cut panels and carry out any operation that could lead to the generation of dust, it is advisable to install an appropriate extraction and reduction system.

When this is not possible or concentrations of dust in the working environment remain at high concentrations, the possibility of isolating the dust production area or providing operators with devices for the protection of the respiratory tract is evaluated.

Hands protection

The presence of steel sheets can cause cuts or injuries to the skin tissue, and in this regard during normal operations involving the handling of panels, leather or hide gloves resistant to abrasion, cutting, tearing and perforation must be worn in conformity with the UNI EN 388 standard.

Eyes protection

Normal use does not require any protection for the eyes. If it is necessary for work activities to cut panels and carry out any operation that could lead to the production of shards or projectile particles, it is advisable to wear polycarbonate glasses to protect against the projection of

particles at high speed / low impact energy; compliant with standard EN 166.

Skin protection

Normal use does not require any specific protection other than work clothes.

Control of the environmental exposure

Normal use does not require any specific measure to reduce environmental exposure as the product is to be considered non-toxic. Should it be necessary to cut panels and carry out any operation that could lead to the generation of dust, install an extraction system with an appropriate abatement system in order to limit environmental pollution.

9. Physical and chemical properties

Appearance: the product comes in the form of a panel clad in metal and a core of straw-coloured expanded polyurethane foam.

Odour: Odourless

Boiling point: not applicable

Melting point: the sheet melts based on the metal, the polyurethane does not melt or drip.

Flash point: polyurethane between 300 and 400°C.

Calorific value: 6500-7500 kcal / kg

Auto-ignition: not applicable

Explosive properties: not applicable

Oxidizing properties: not applicable

Vapour pressure: not applicable

Water solubility: not applicable

Fat solubility: not applicable

Partition coefficient: not applicable

10. Stability and reactivity

Pre-painted steel and polyurethane are stable under normal weather conditions.

Conditions to avoid:

Avoid using naked flames near polyurethane dust.

11. Toxicological information

With the present state of knowledge, the material is to be considered non-toxic.

12. Ecological information

There are no known harmful effects on the environment.

Should it be necessary to cut panels and carry out any operation that could lead to the generation of dust, install an extraction system with an appropriate abatement system in order to limit environmental pollution.

13. Disposal considerations

The disposal of polyurethane insulated panels must only be entrusted to authorized companies and carried out in compliance with the laws in force.

14. Transport information

No special measures must be taken during transport.

15. Regulatory information

No restrictions pursuant to Annex XVII of the REACH Regulation. No ingredient is included in the REACH Candidate List (> 0.1 % m/m). Regulation (EC) No. 1907/2006 of the European Parliament and of the Council, of December 18, 2006, concerning the registration, evaluation, authorization and restriction of chemical substances (REACH).

Regulation (EC) No. 1272/2008 of the European Parliament and of the Council of December 16, 2008 concerning the classification, labelling and packaging of substances and mixtures which amends and repeals Directives 67/548/EEC and 1999/45/EC and amends regulation (EC) No. 1907/2006.

Regulation 830/2015 Annex II of REACH.

Legislative decree 81/2008 Consolidated Law on Occupational Health and Safety.

16. Other information

The information contained in this sheet are based on our knowledge and experience at the date of the latest version. The user must verify the suitability and completeness of the information in relation to the specific use of the product.

This document must not be interpreted as a guarantee of any specific property of the product. Since the use of the product does not fall under our direct control, it is the user's obligation under its responsibility to observe the laws and regulations in force concerning hygiene and safety.

No liability is assumed for improper use. Provide adequate training for the personnel involved in the use of chemical products.



Registered seat:

via Bresciani 16 • 46040 Gazoldo degli Ippoliti (MN) - Italy
phone + 39 . 0376 6851

tamponamento@marcegaglia.com

www.marcegagliabuildtech.it

Main offices and plant:

MARCEGAGLIA Pozzolo Formigaro

Strada Roveri 4 • 15068 Pozzolo Formigaro (AL) - Italy
phone + 39 0143 7761

pozzolo@marcegaglia.com