



revisione 3.0 dicembre 2016

SM8 "POOL STAIR" 1800x1800



304080902 BASETTA REGOLABILE H 355 MM Z.EL. 2,49



3040701006 SPINA D. 10 MM Z.TR. 0,12

3150100121 SM8 MONTANTE 2500 MM - SPIN. 38X2 Z.C. 12,20
3150100131 SM8 MONTANTE 2000 MM - SPIN. 38X2 Z.C. 9,86

3150200251 SM8 CORRENTE DA 1800 MM Z.C. 7,35



3150300831 SM8 CORRENTE RINFORZATO EN 1800 MM Z.C. 13,00

3150500121 SM8 DIAGONALE VISTA 1800X2000 MM Z.C. 6,96



3150400111 SM8 DIAGONALE PIA. 1800X1800 MM Z.C. 6,26

3150300851 SM8 SCALA 1800X1800 FERM.INT. L=1016 Z.S. 2,50
3150300841 SM8 SCALA 1800X1800 FERM.INT. L=1026 Z.S. 2,40
3150300841 SM8 SCALA 1800X1800 FERM.INT. L=1800 Z.S. 4,77

3150300461 SM8 SCALA 1800X1800 RAMPA SCALA Z.C. 43,73



3150300471 SM8 SCALA 1800X1800 PARAPET ESTERNO Z.C. 13,40



3150300481 SM8 SCALA 1800X1800 PARAPET INTERNO Z.C. 6,71



3150300531 SM8 SCALA 1800X1800 SBARCO START Z.C. 31,65



3150300511 SM8 SCALA 1800X1800 PARA START/STOP Z.C. 22,28

3150300551 SM8 SCALA 1800X1800 SPINA Ø12 L=120 Z.C. 0,12
3150300561 SM8 SCALA 1800X1800 SPINA Ø12 L=70 Z.C. 0,07

3153000571 SM8 FISSAGGIO GRADINI SCALA Z.C. 0,03

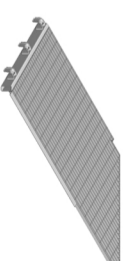

3150300531 SM8 SCALA 1800X1800 SBARCO START Z.C. 31,65

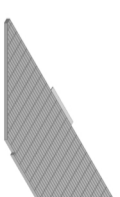

3150300521 SM8 SCALA 1800X1800 SBARCO INTERNE Z.C. 22,00



3150300541 SM8 SCALA 1800X1800 SBARCO STOP Z.C. 31,65

lista articoli

distinta materiale

CODICE	ARTICOLO	H2	H4	H6	H8	H10	H12	H14	H16	H18	H20	H22	H24	H26	H28	H30	H32	H34	H36	H38	H40
3040501062	BASETTA REGOLABILE H 355 MM Z.EL.	4	4	4	4	4	4	4	4	4	4	4	4	4	4	4	4	4	4	4	4
3040701006	SPINA D. 10 MM Z.TR.	4	8	12	16	20	24	28	32	36	40	48	48	52	56	60	64	68	72	76	80
3150100121	SM8 MONTANTE 2500 MM - SPIN. 38X2 Z.C.	4	4	4	4	4	4	4	4	4	4	4	4	4	4	4	4	4	4	4	4
3150100131	SM8 MONTANTE 2000 MM - SPIN. 38X2 Z.C.	4	8	12	16	20	24	28	32	36	40	48	48	52	56	60	64	68	72	76	80
3150200251	SM8 CORRENTE DA 1800 MM Z.C.	16	22	28	34	40	46	52	58	64	70	82	82	88	94	100	106	112	118	124	130
3150300461	SM8 SCALA 1800X1800 RAMPA SCALA Z.C.	2	4	6	8	10	12	14	16	18	20	24	24	26	28	30	32	34	36	38	40
3150300471	SM8 SCALA 1800X1800 PARAPET. ESTERNO Z.C.	2	4	6	8	10	12	14	16	18	20	24	24	26	28	30	32	34	36	38	40
3150300481	SM8 SCALA 1800X1800 PARAPET. INTERNO Z.C.	2	4	6	8	10	12	14	16	18	20	24	24	26	28	30	32	34	36	38	40
3150300491	SM8 SCALA 1800X1800 RACCORDO PARAP. INT. Z.C.	1	3	5	7	9	11	13	15	17	19	23	23	25	27	29	31	33	35	37	39
3150300511	SM8 SCALA 1800X1800 PARA. START/STOP Z.C.	2	2	2	2	2	2	2	2	2	2	2	2	2	2	2	2	2	2	2	2
3150300521	SM8 SCALA 1800X1800 SBARCO INTERME. Z.C.	1	3	5	7	9	11	13	15	17	19	23	23	25	27	29	31	33	35	37	39
3150300531	SM8 SCALA 1800X1800 SBARCO START Z.C.	1	1	1	1	1	1	1	1	1	1	1	1	1	1	1	1	1	1	1	1
3150300541	SM8 SCALA 1800X1800 SBARCO STOP Z.C.	1	1	1	1	1	1	1	1	1	1	1	1	1	1	1	1	1	1	1	1
3150300551	SM8 SCALA 1800X1800 SPINA Ø12 L=120 Z.C.	4	8	12	16	20	24	28	32	36	40	48	48	52	56	60	64	68	72	76	80
3150300561	SM8 SCALA 1800X1800 SPINA Ø12 L=70 Z.C.	4	8	12	16	20	24	28	32	36	40	48	48	52	56	60	64	68	72	76	80
3150300831	SM8 CORRENTE RINFORZATO EN 1800 MM Z.C.	5	7	9	11	13	15	17	19	21	23	27	27	29	31	33	35	37	39	41	43
3150300841	SM8 SCALA 1800X1800 FERM. INT. L=1800 Z.S.	1	2	3	4	5	6	7	8	9	10	12	12	13	14	15	16	17	18	19	20
3150300851	SM8 SCALA 1800X1800 FERM. INT. L=1016 Z.S.	1	1	1	1	1	1	1	1	1	1	1	1	1	1	1	1	1	1	1	1
3150300861	SM8 SCALA 1800X1800 FERM. INT. L=1026 Z.S.	1	1	1	1	1	1	1	1	1	1	1	1	1	1	1	1	1	1	1	1
3150400111	SM8 DIAGONALE PIA. 1800X1800 MM Z.C.	1	1	1	1	1	1	1	1	1	1	1	1	1	1	1	1	1	1	1	1
3150500121	SM8 DIAGONALE VISTA 1800X2000 MM Z.C.	6	12	15	18	21	24	27	30	33	36	42	42	45	48	51	54	57	60	63	66
3153000571	SMP8 FISSAGGIO GRADINI SCALA Z.C.	8	16	24	32	40	48	56	64	72	80	96	96	104	112	120	128	136	144	152	160

sideviews

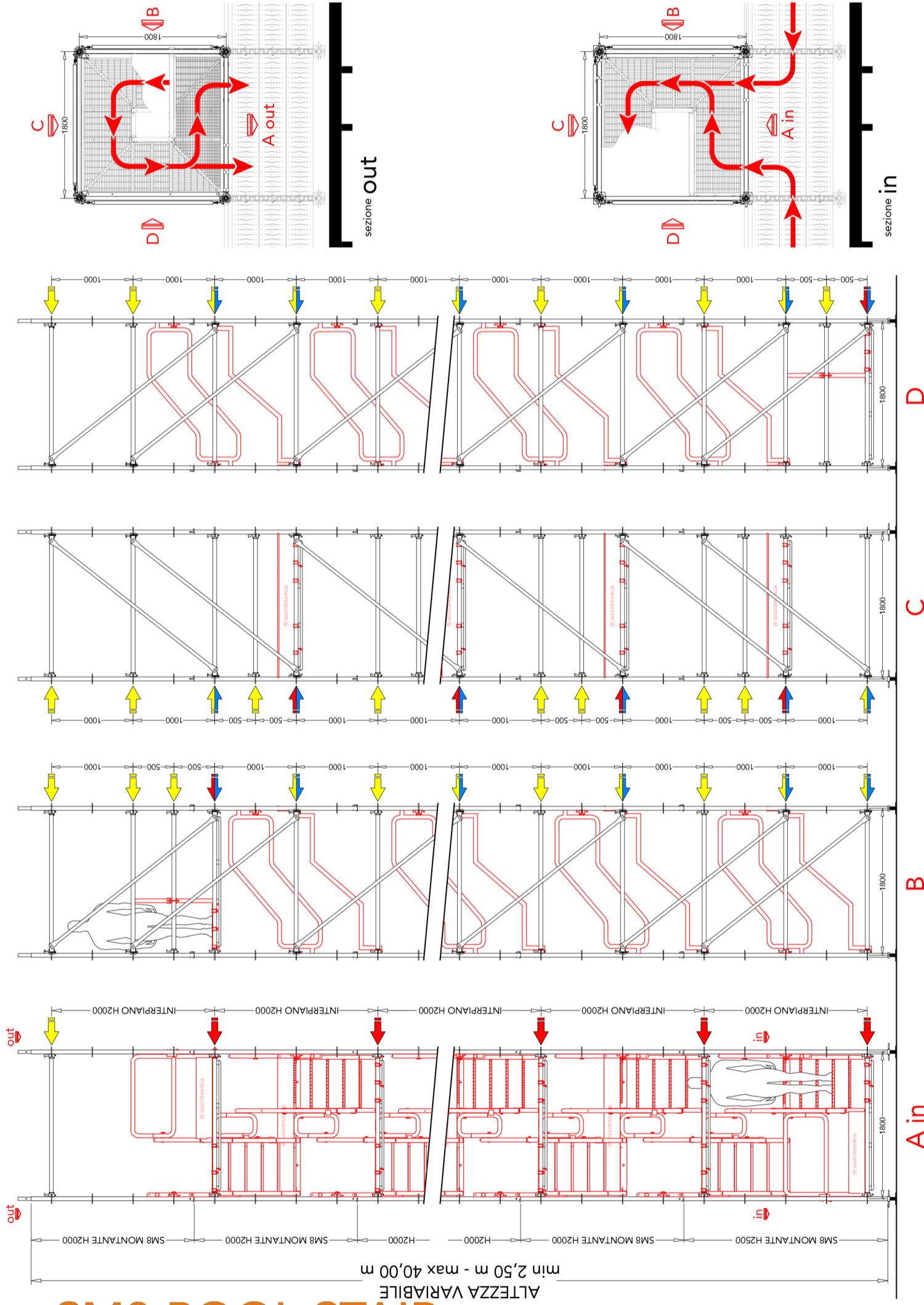

per ogni lato della torre (A, B, C, D) sul piattello ottagonale del montante indicato dalla freccia, connettere:

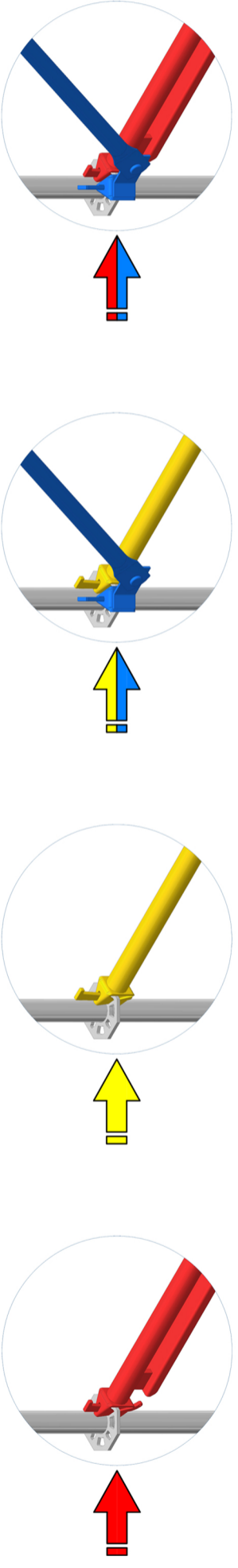

- SM8 CORRENTE RINFORZATO 1800
- SM8 DIAG.VISTA 1800x2000
- SM8 CORRENTE 1800
- SM8 DIAG.VISTA 1800x2000
- SM8 CORRENTE 1800
- SM8 CORRENTE RINFORZATO 1800

SM8 POOL STAIR

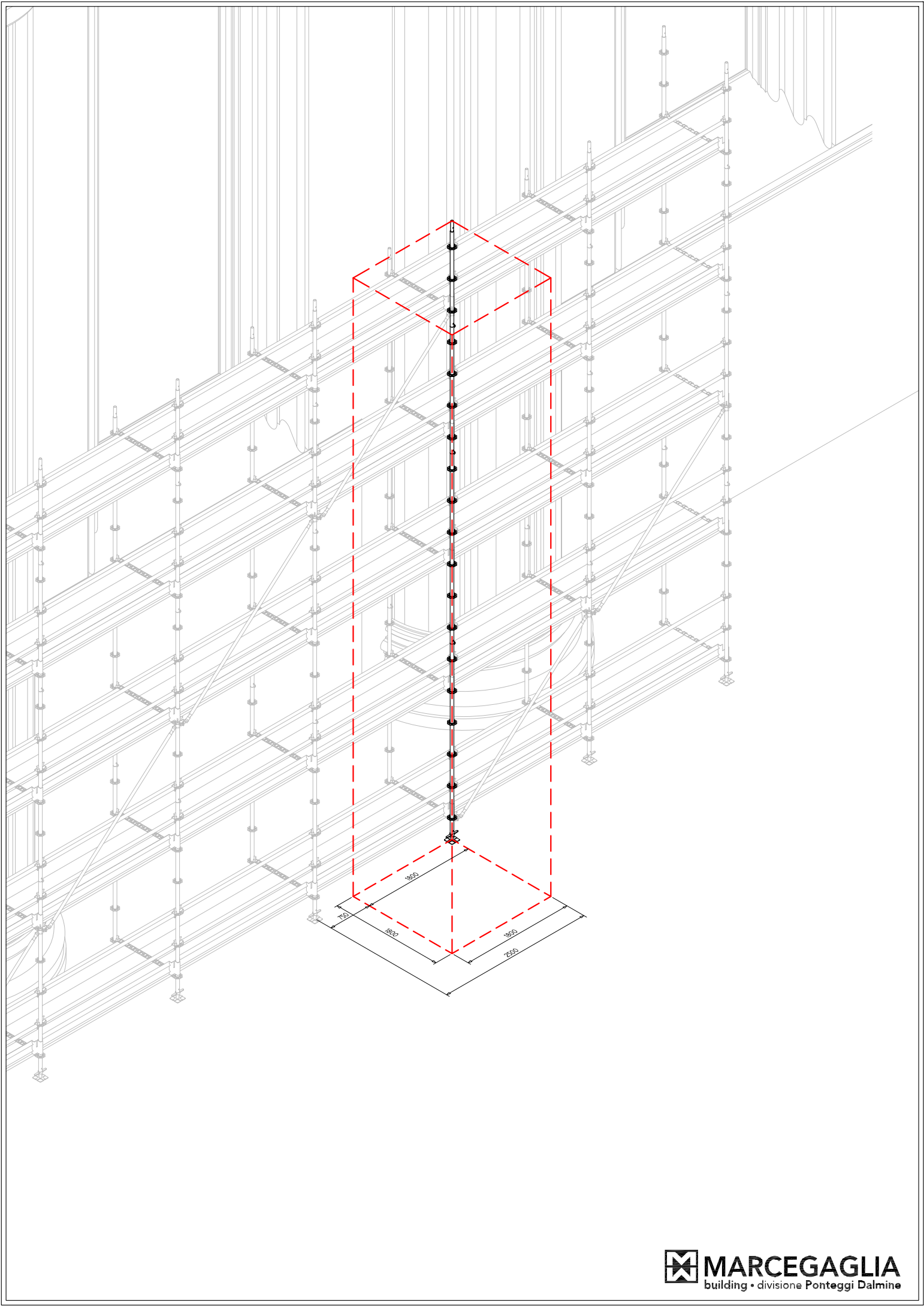

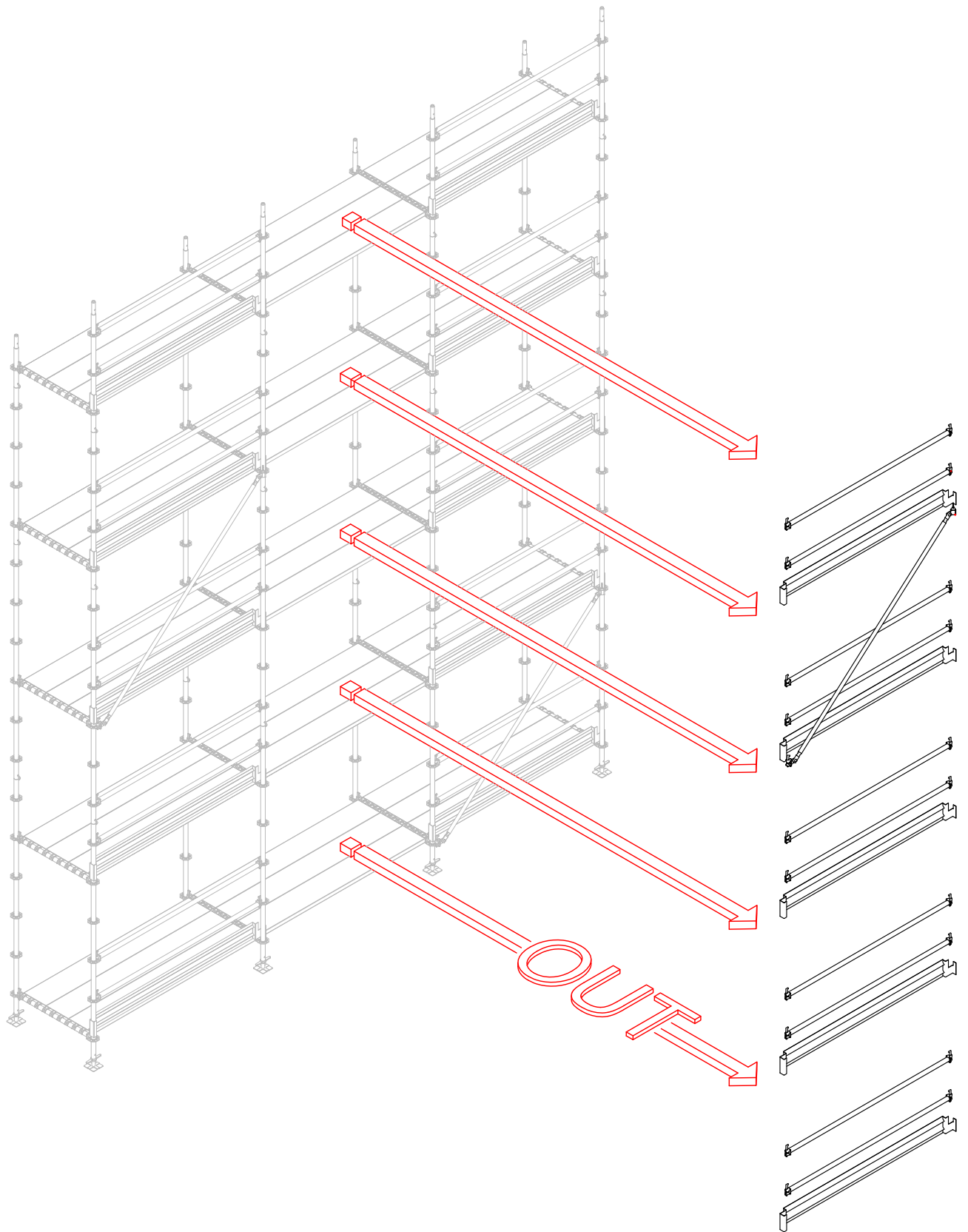

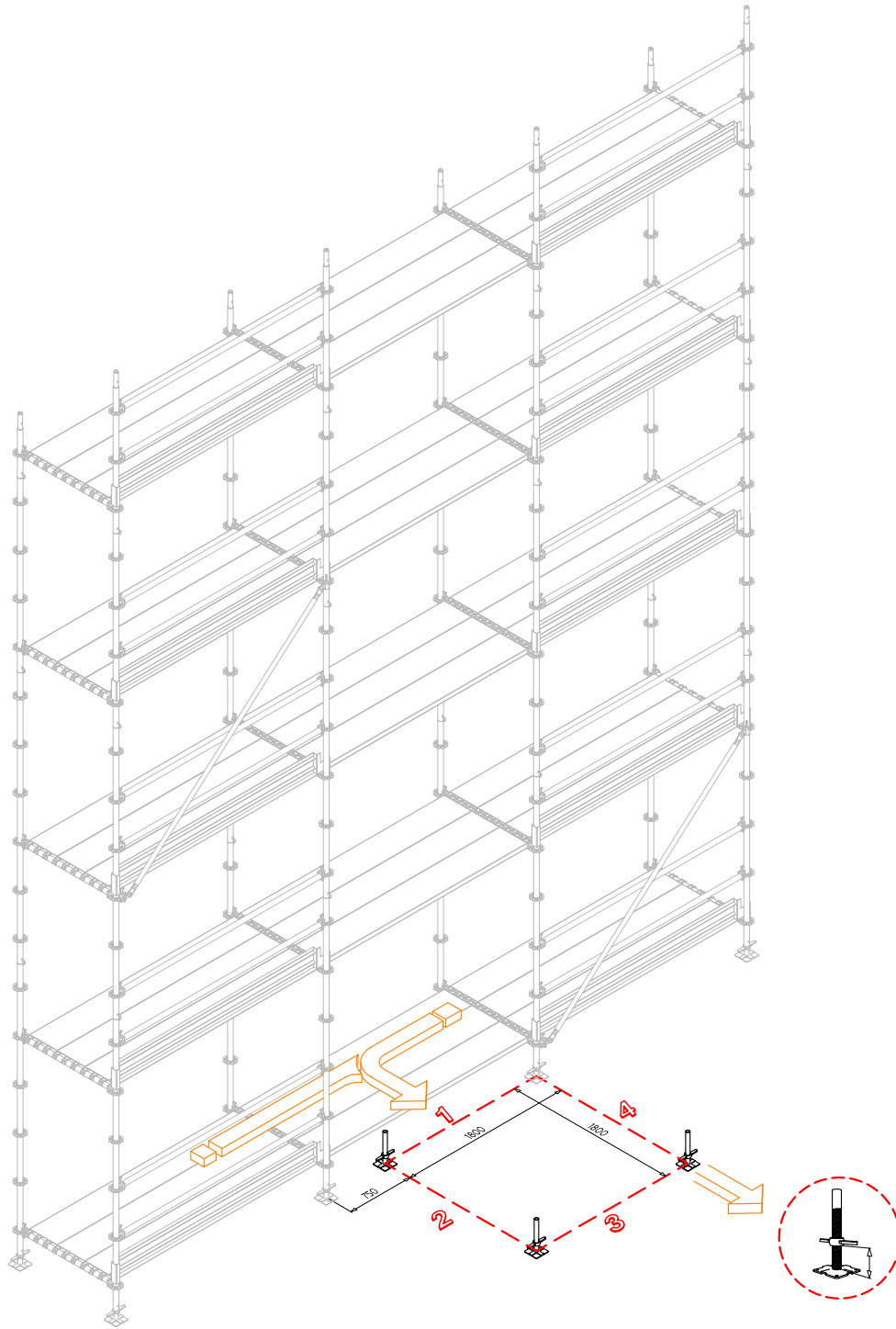

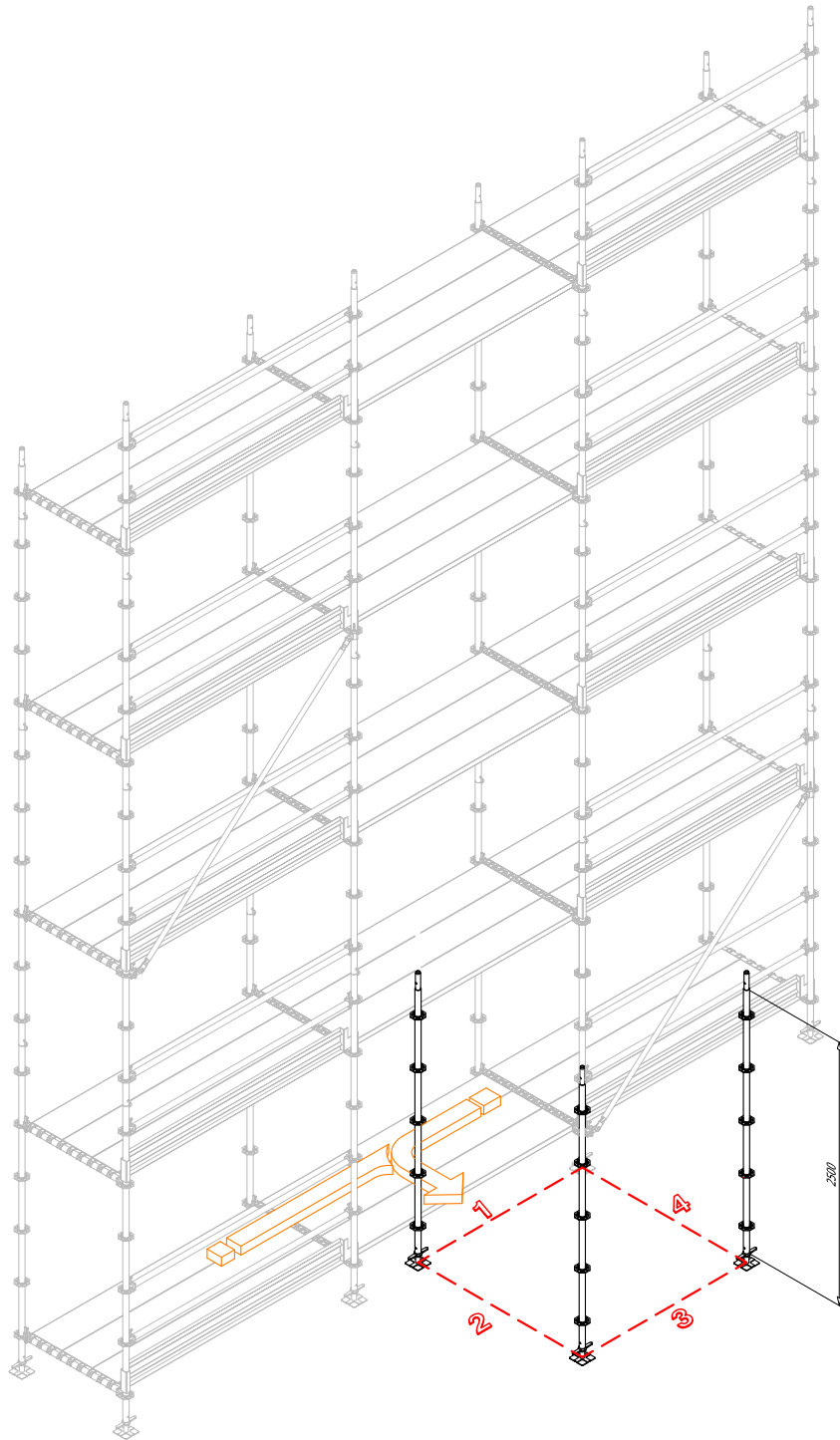

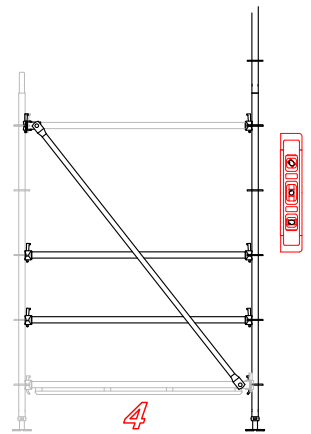
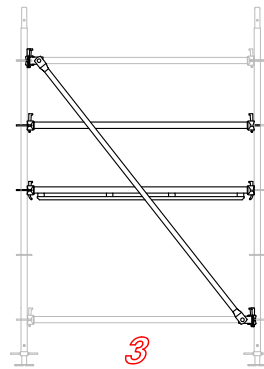
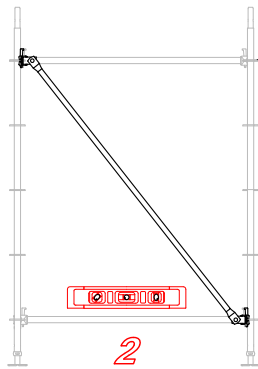
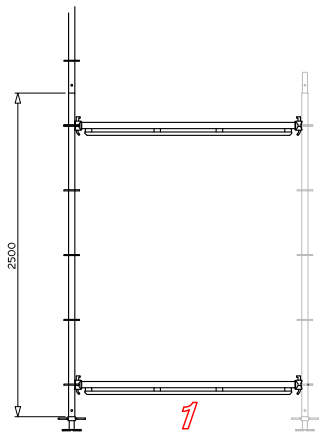
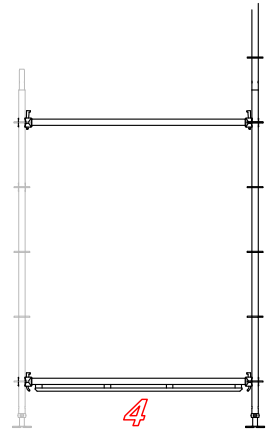
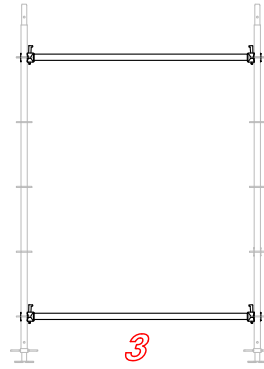
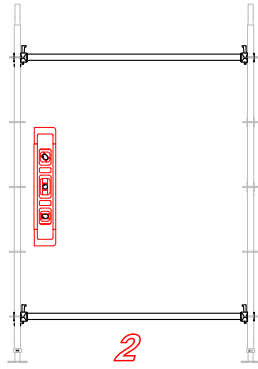
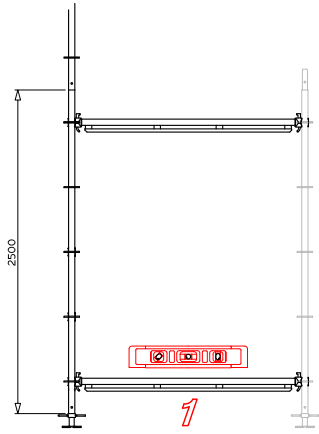
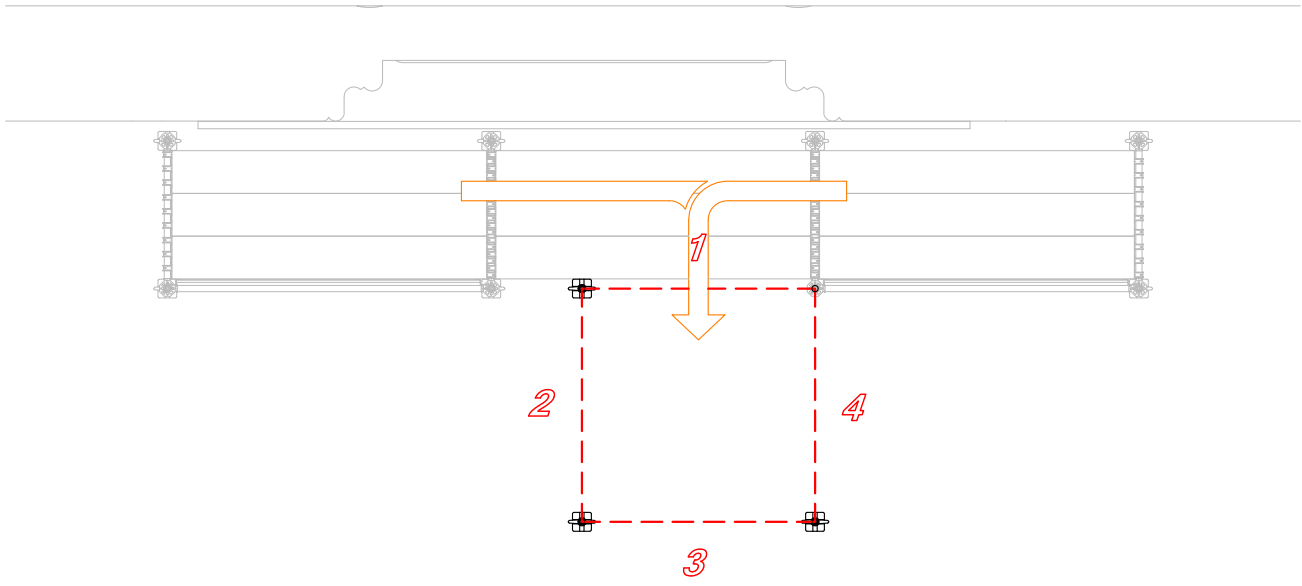

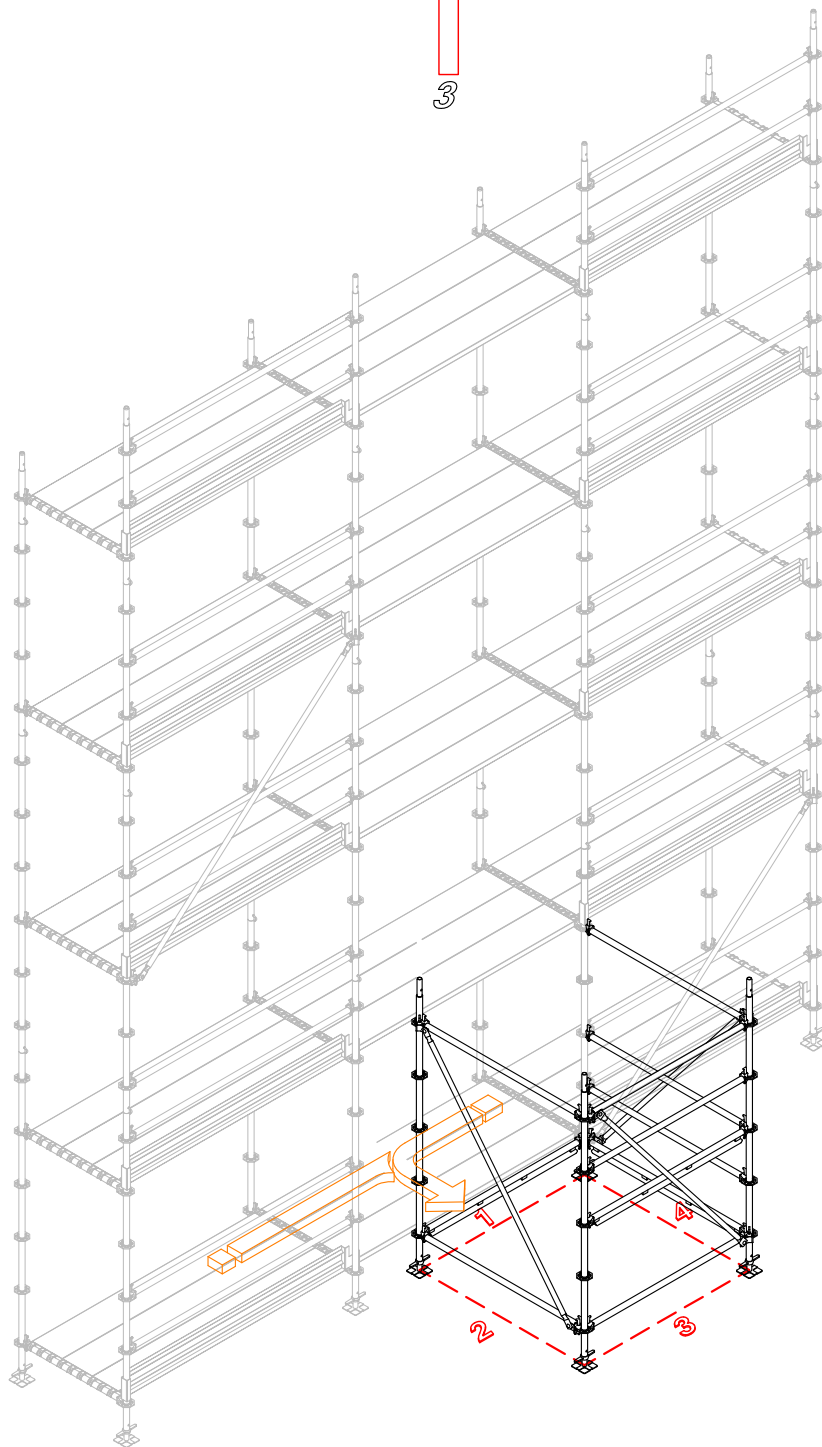
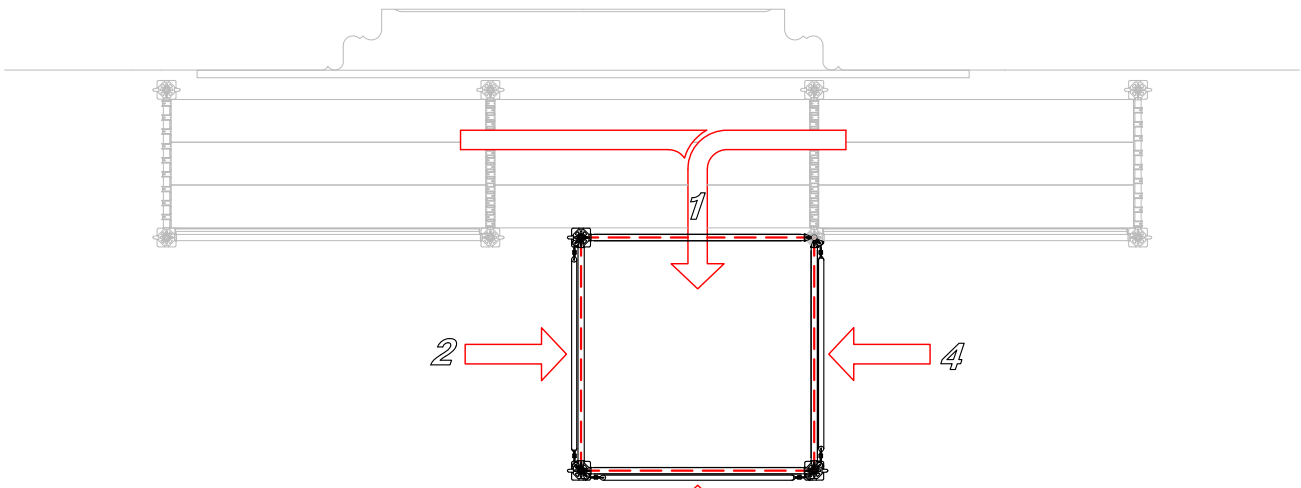

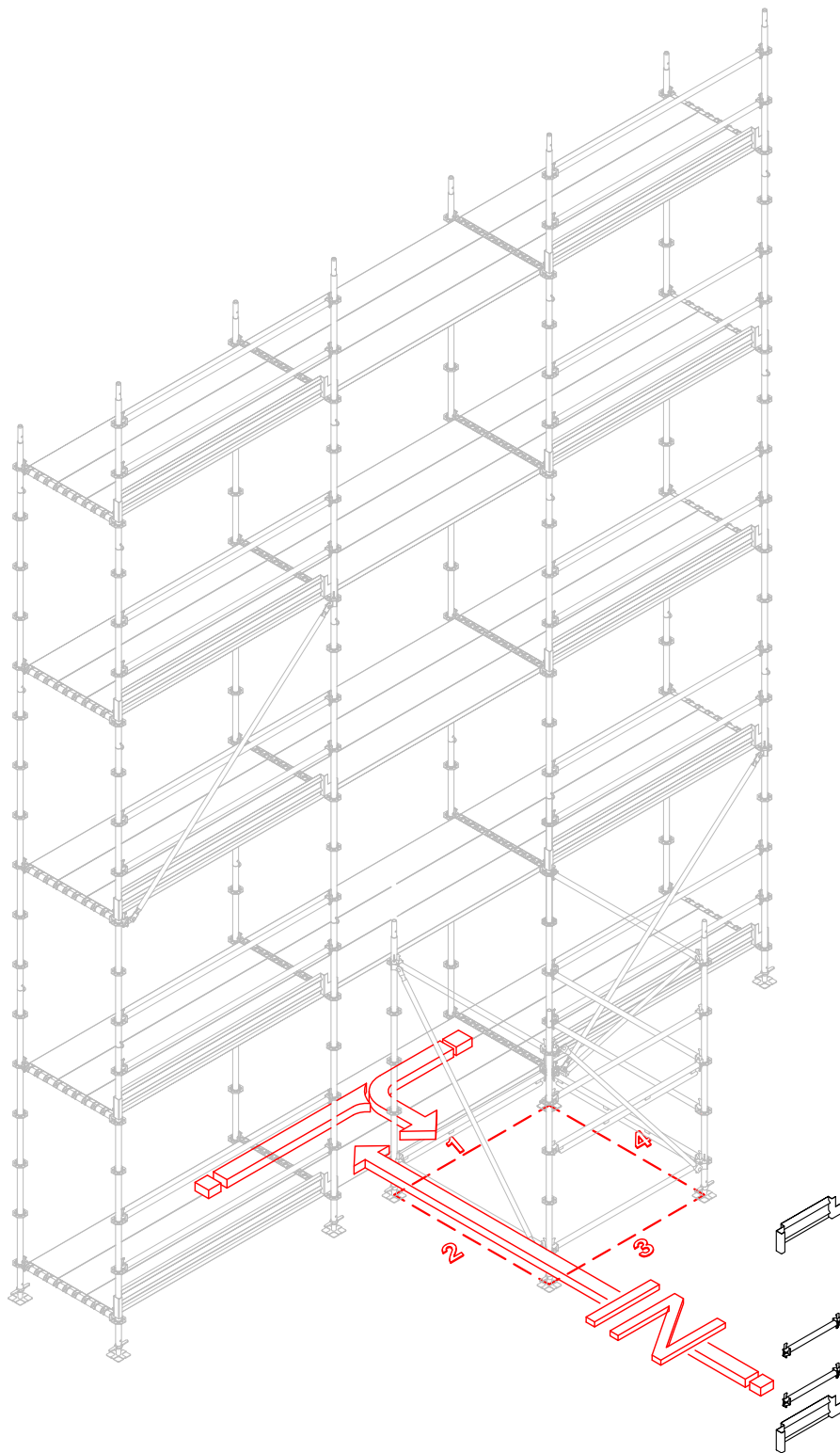

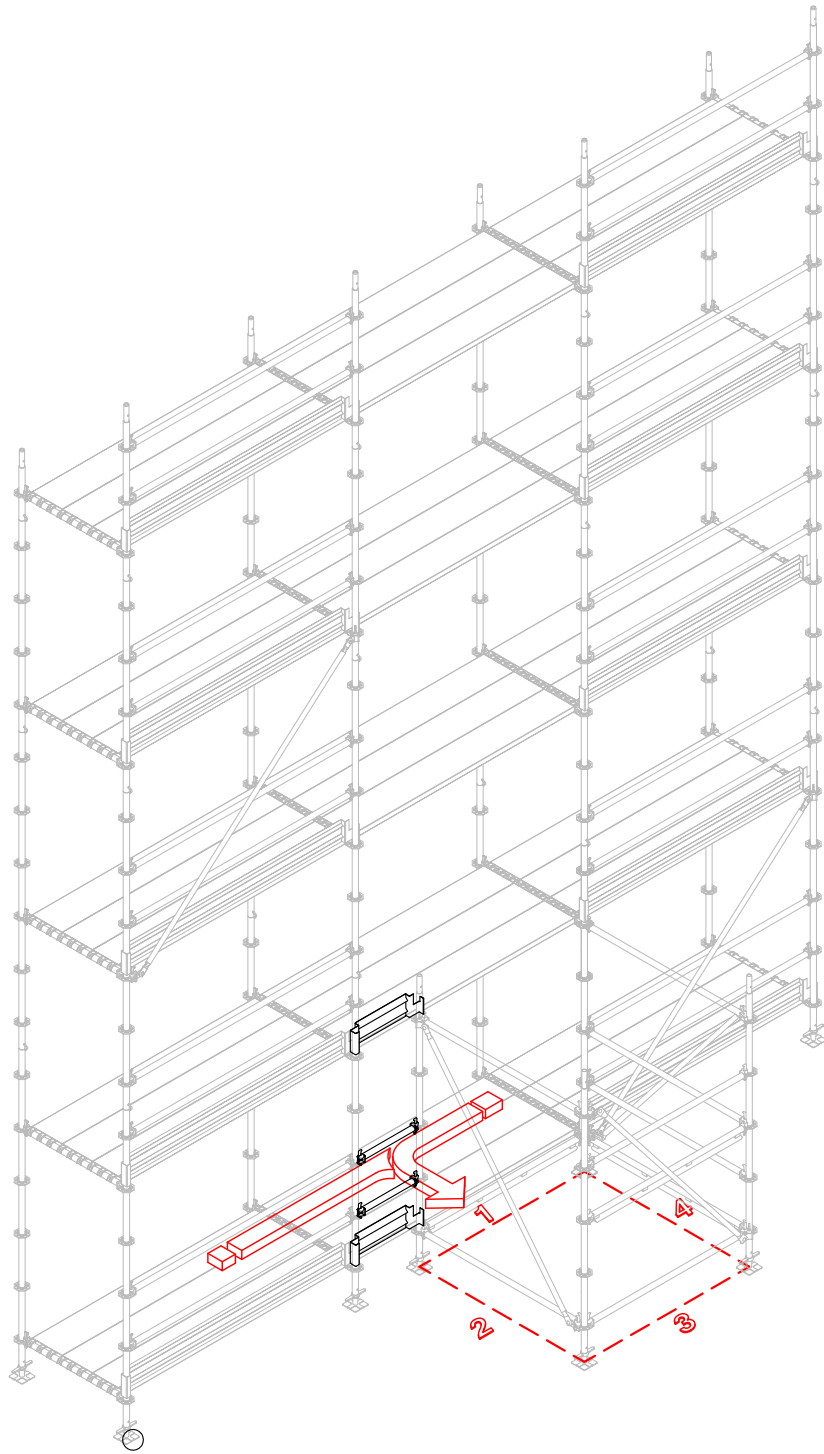

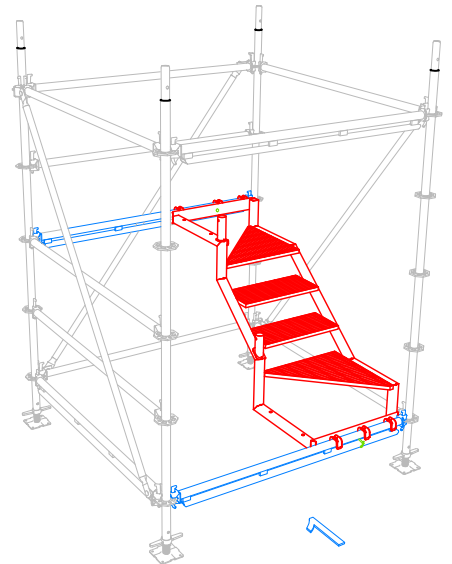
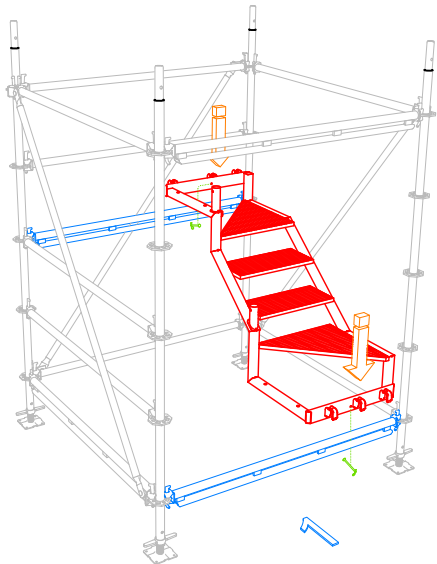
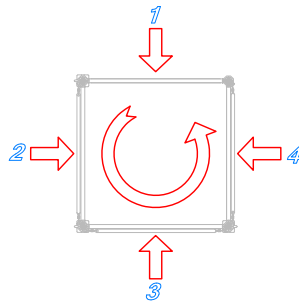
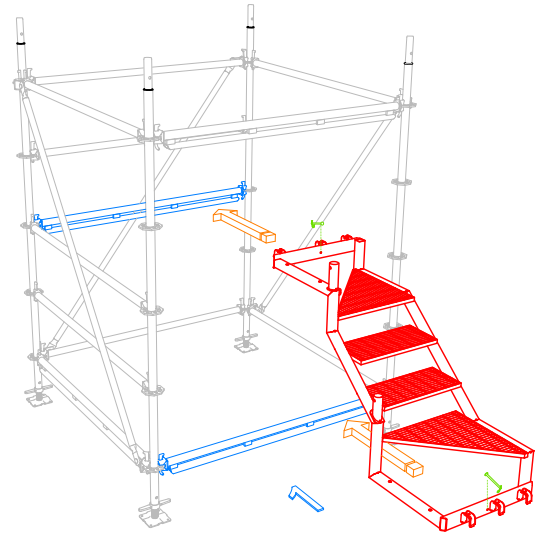
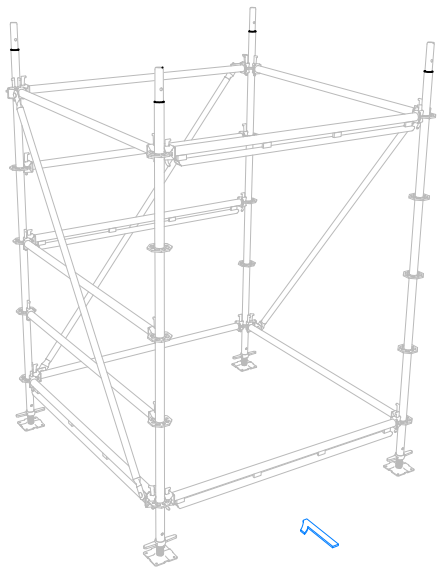

PRIMA FASE:
3150300461 SM8 SCALA 1800X1800 RAMPA SCALA Z.C.

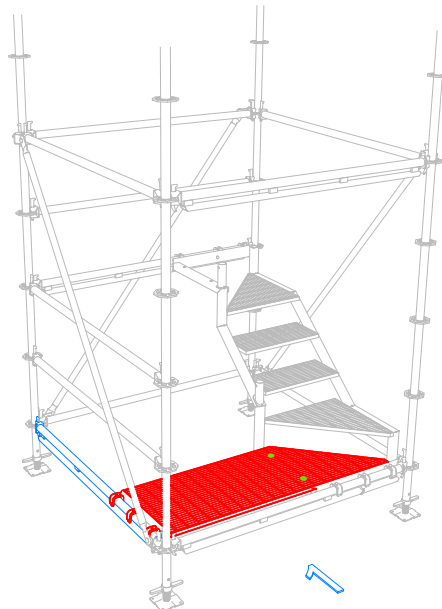
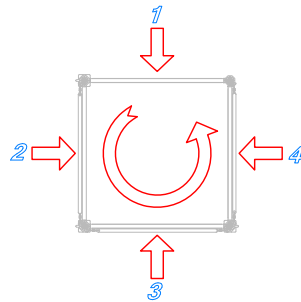
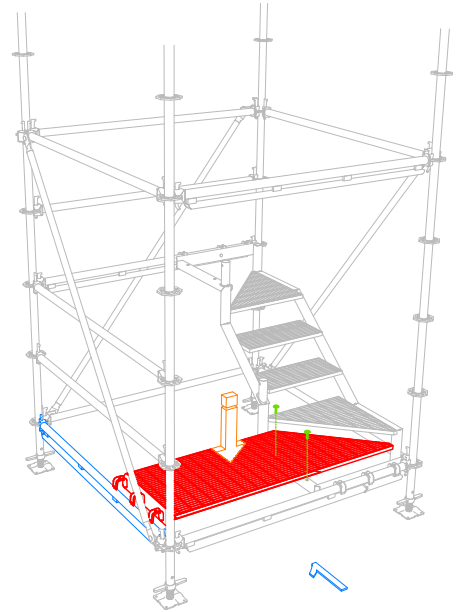
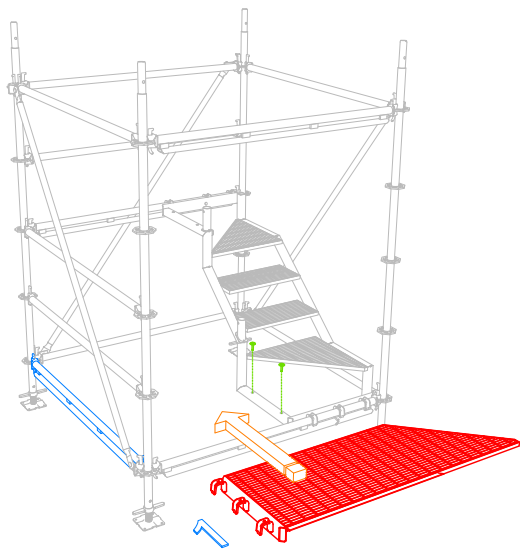

SECONDA FASE:
3150300531SM8 SCALA 1800X1800 SBARCO START Z.C.

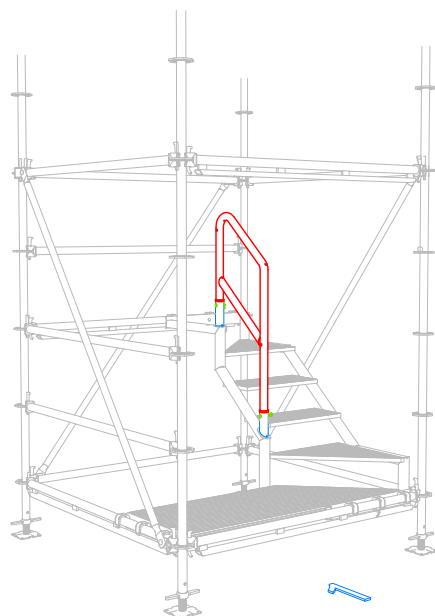
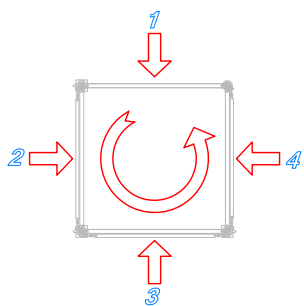
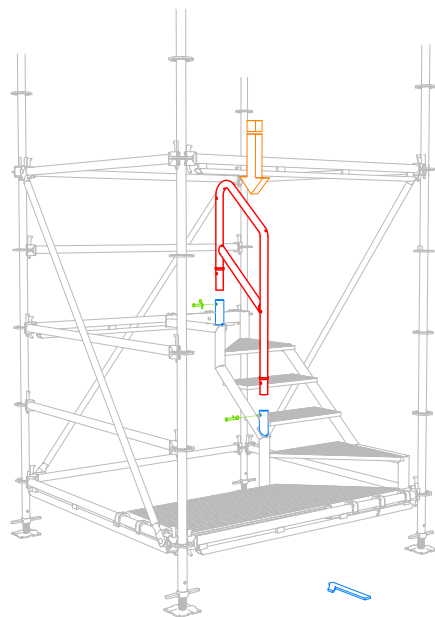

TERZA FASE:
3150300481SM8 SCALA 1800X1800 PARAPET.INTERNO Z.C.

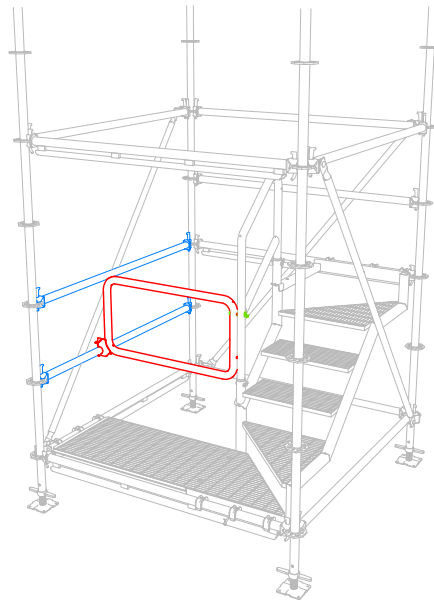
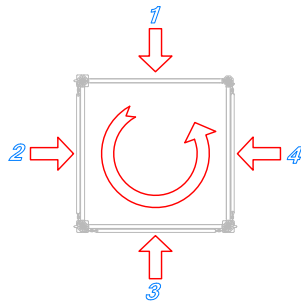
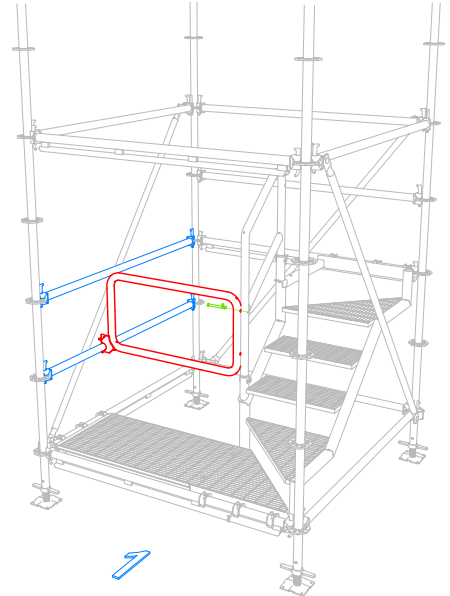
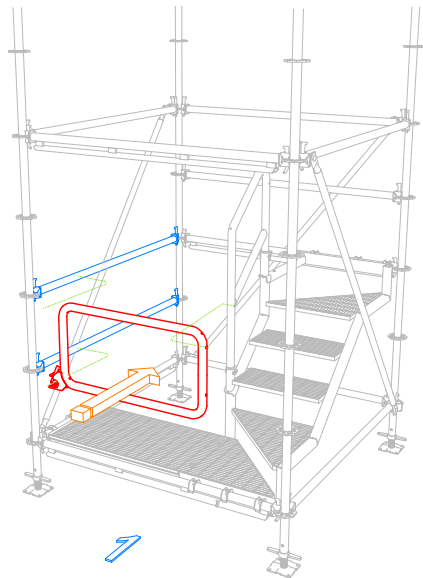

QUARTA FASE:
3150300511SM8 SCALA 1800X1800 PARA.START/STOP Z.C.

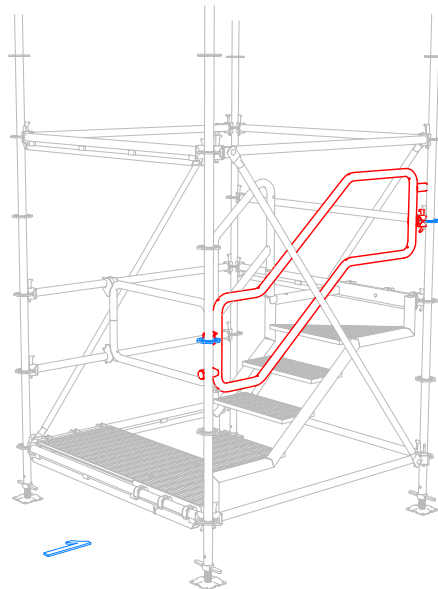
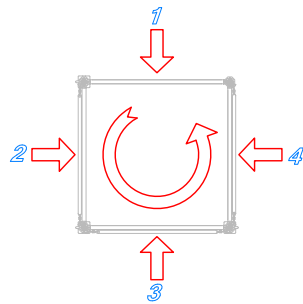
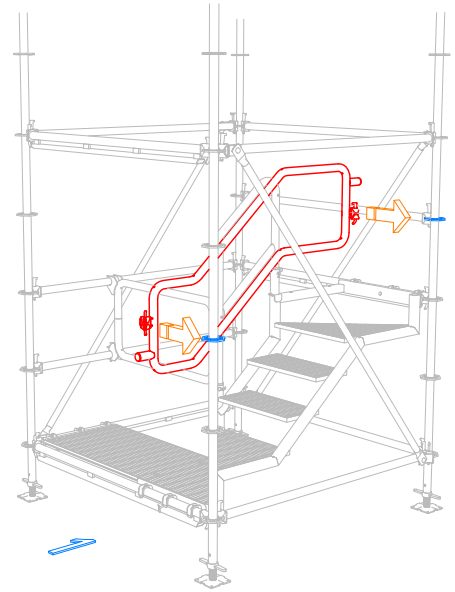
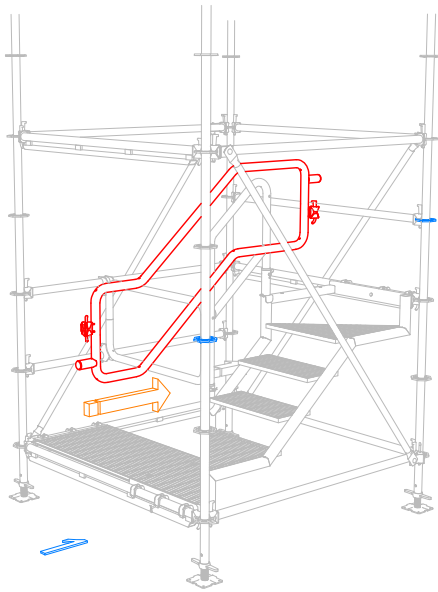

QUINTA FASE:
3150300471SM8 SCALA 1800X1800 PARAPET. ESTERNO Z.C.

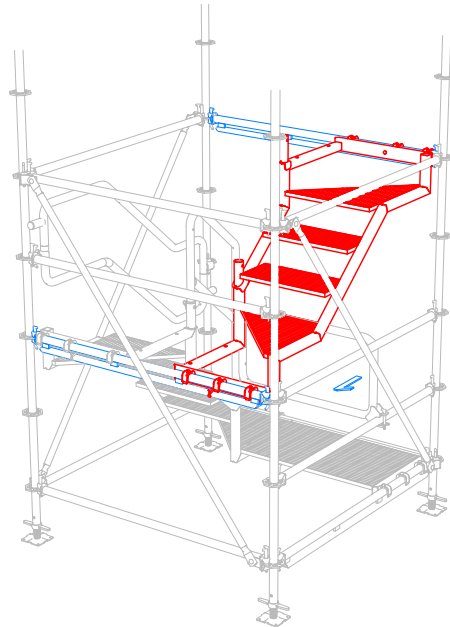
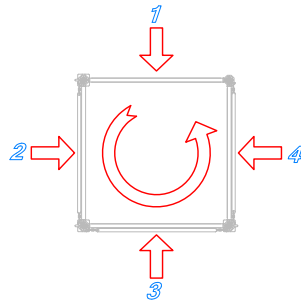
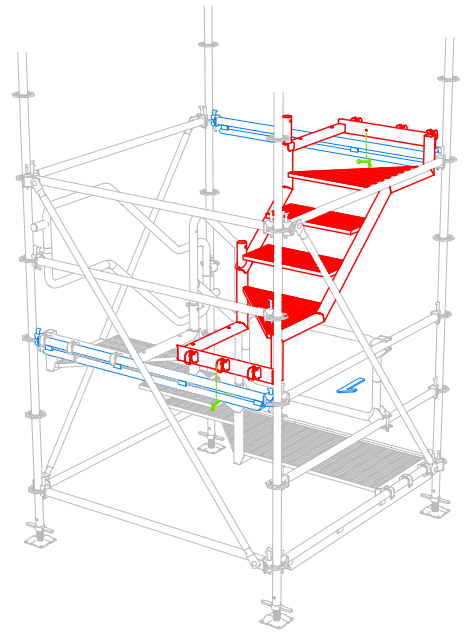
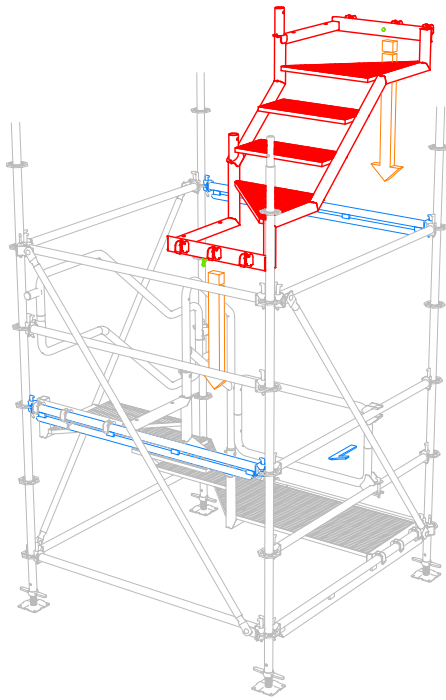

SESTA FASE:
3150300461 SM8 SCALA 1800X1800 RAMPA SCALA Z.C.

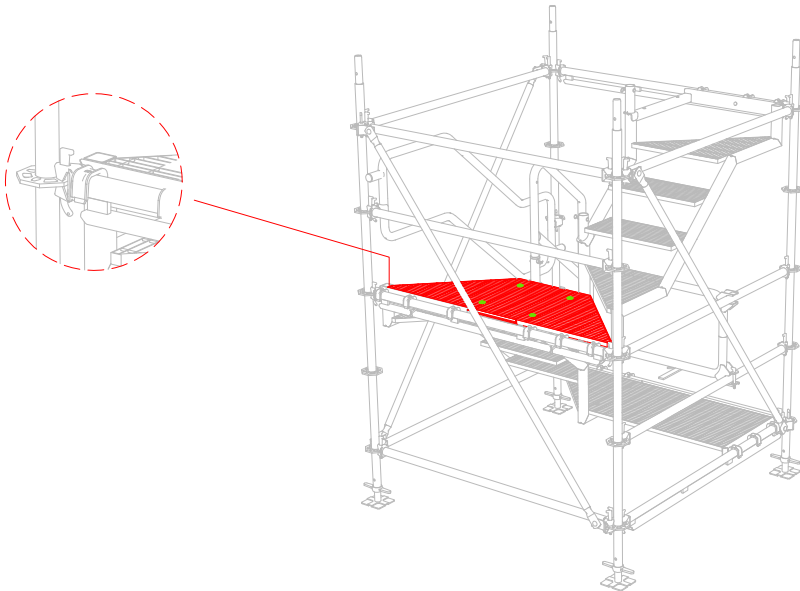
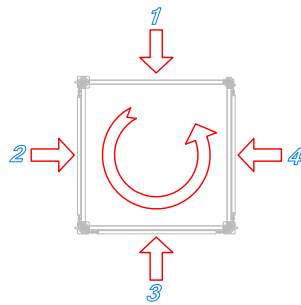
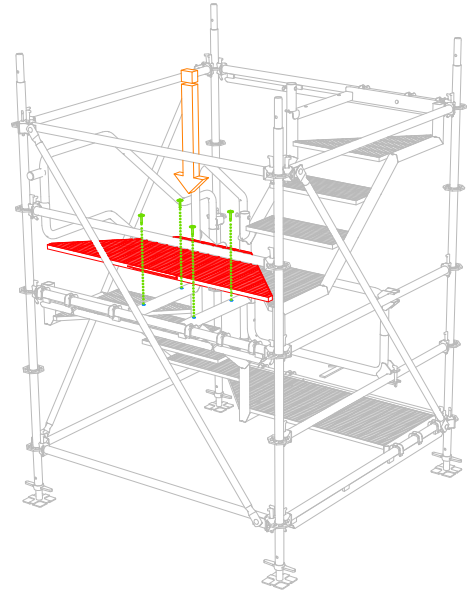
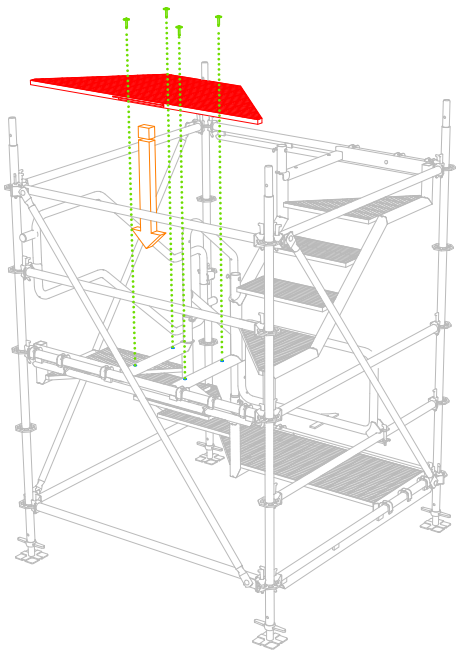

SETTIMA FASE:
3150300521 SM8 SCALA 1800X1800 SBARCO INTERME. Z.C.

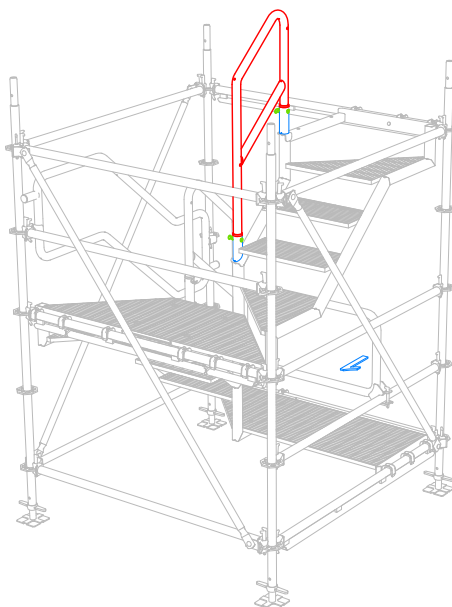
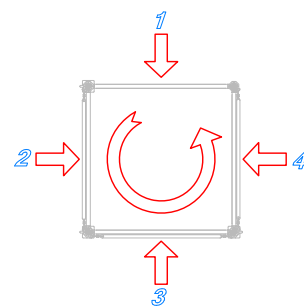
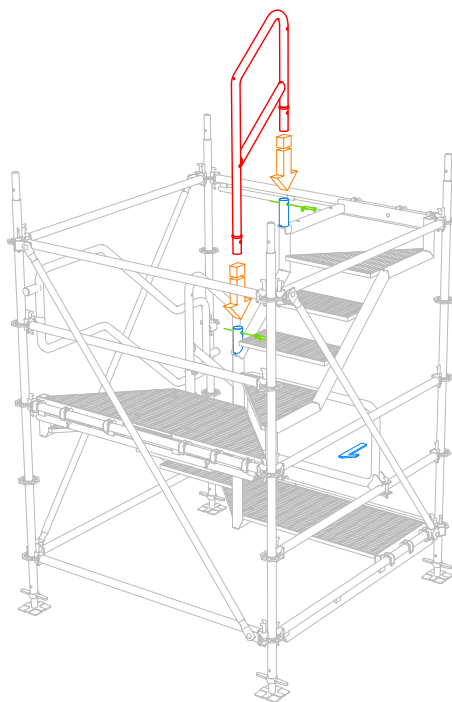

OTTAVA FASE:
3150300461 SM8 SCALA 1800X1800 PARAPET.INTERNO Z.C.

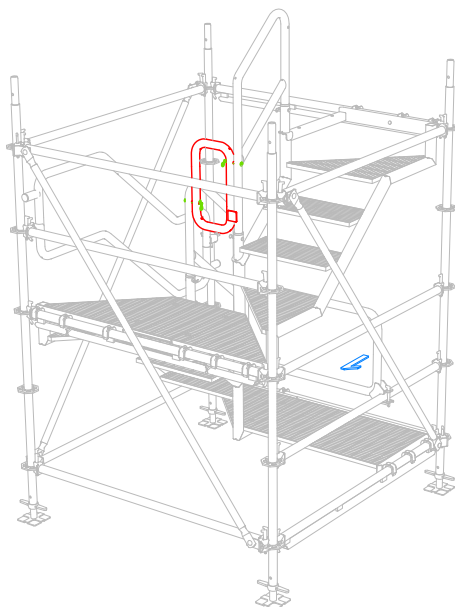
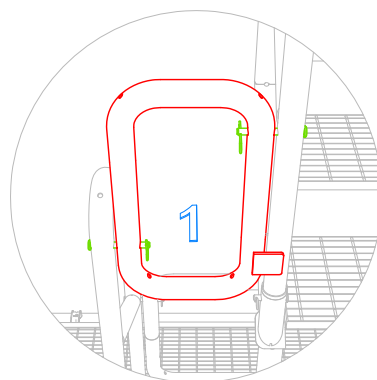
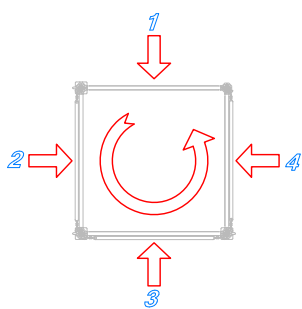
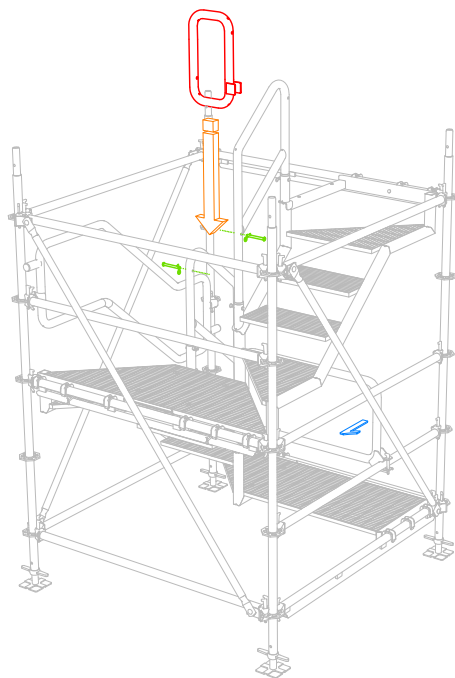

NONA FASE:
3150300461 SM8 SCALA 1800X1800 RACCORDO PARAP.INT. Z.C.

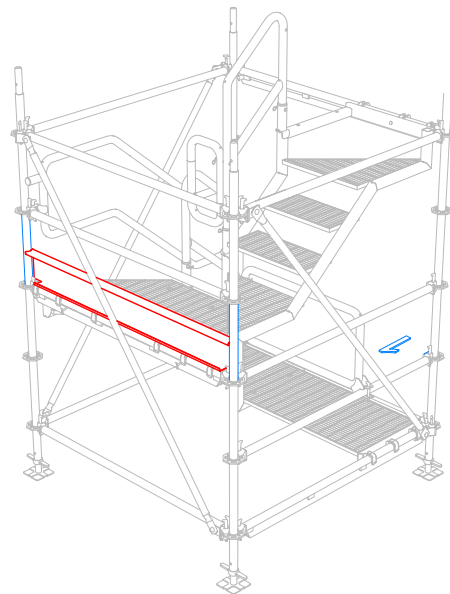
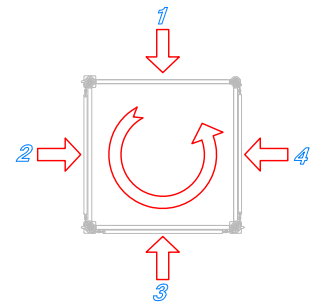
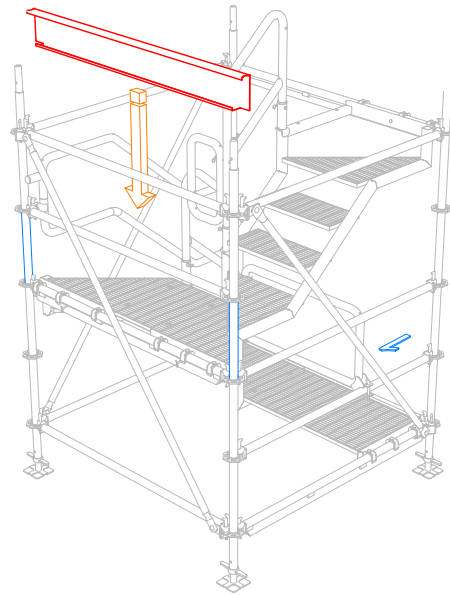

DECIMA FASE:
3150300841 SM8 SCALA 1800X1800 FERM.INT. L=1800 Z.S

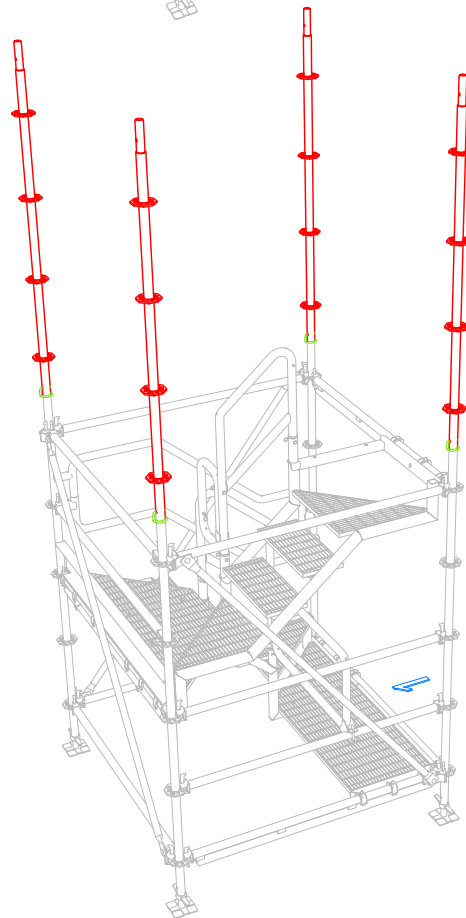
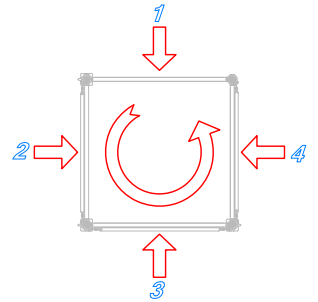
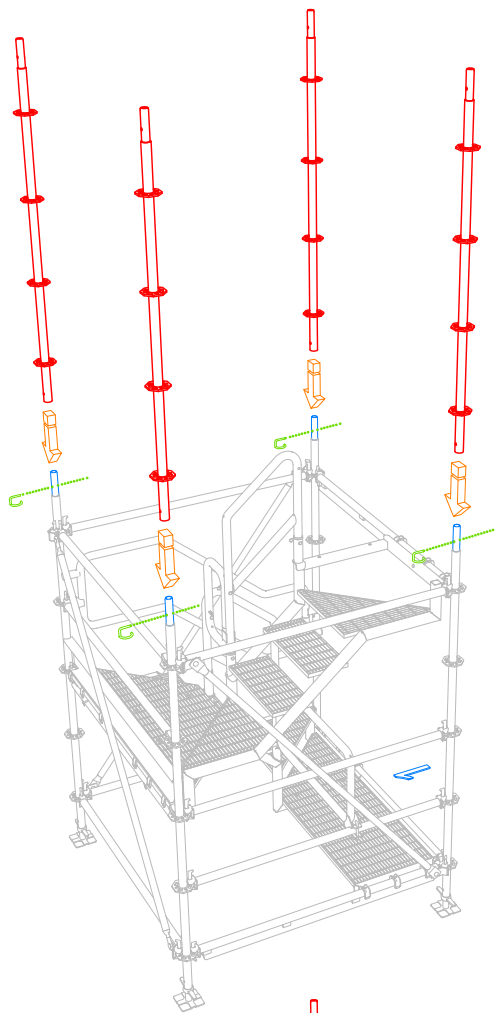

UNDICESIMA FASE:
3150100131 SM8 MONTANTE 2000 MM - SPIN. 38X2 Z.C.

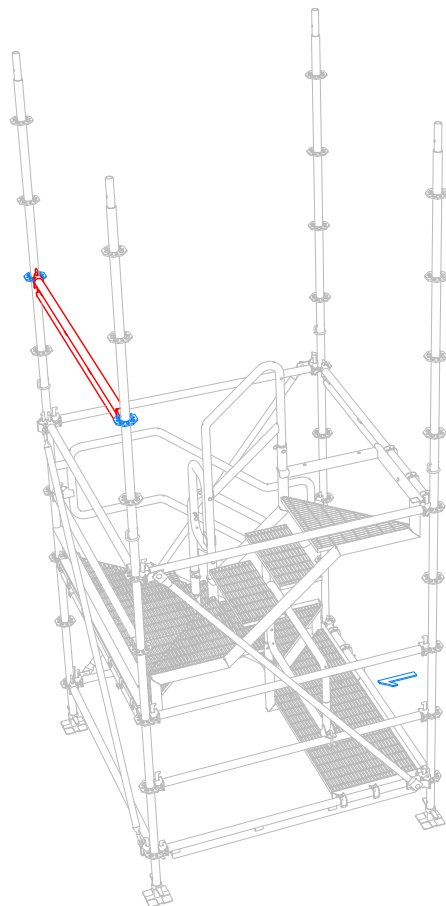
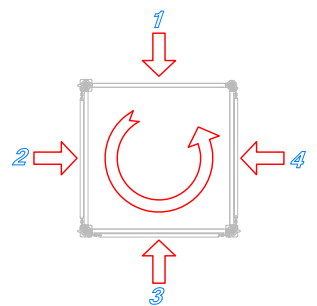
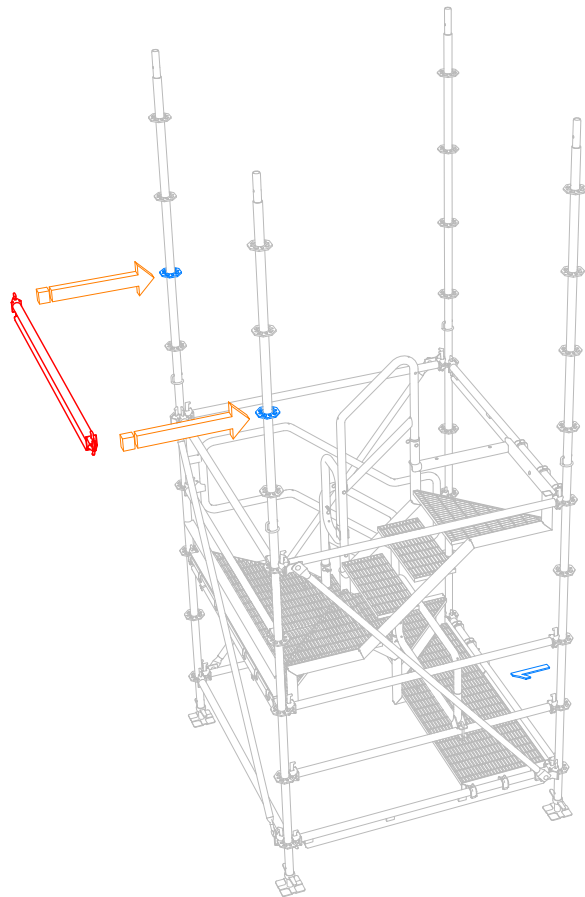

DODICESIMA FASE:
3150300831 SM8 CORRENTE RINFORZATO EN 1800 MM Z.C.

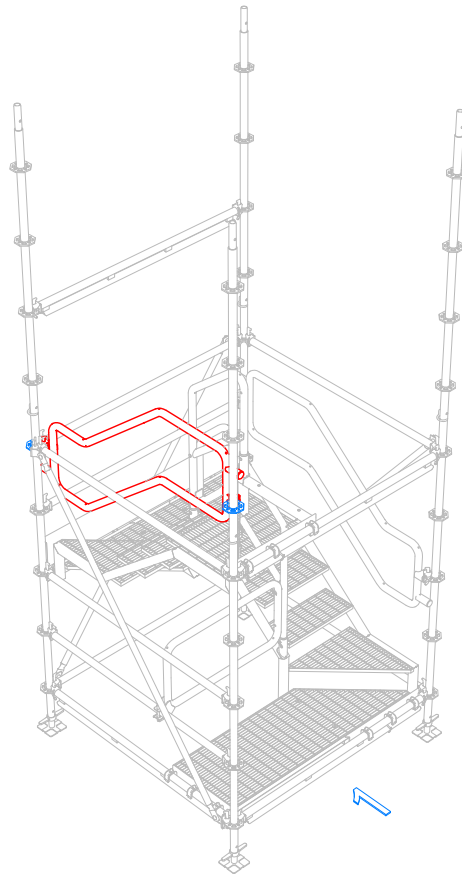
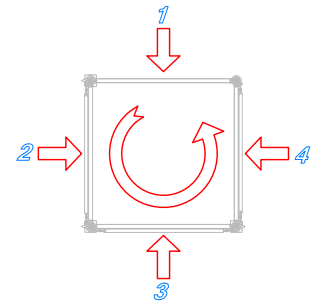
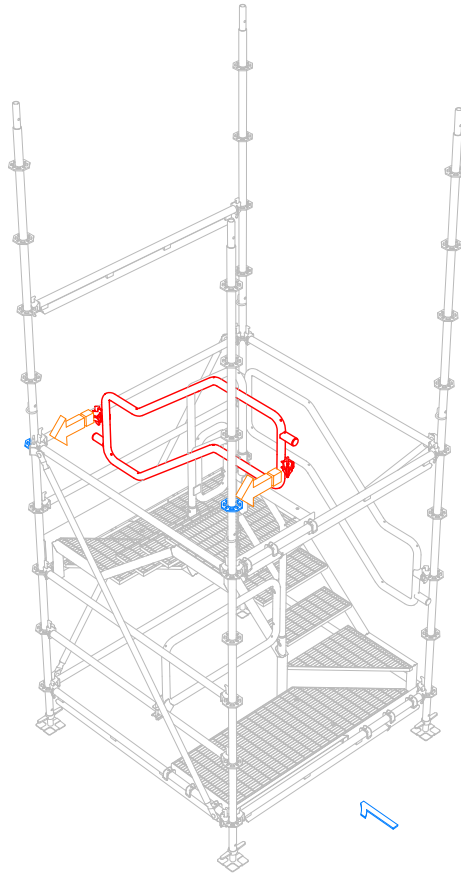

TREDICESIMA FASE:
SM8 SCALA 1800X1800 PARAPET. ESTERNO Z.C.

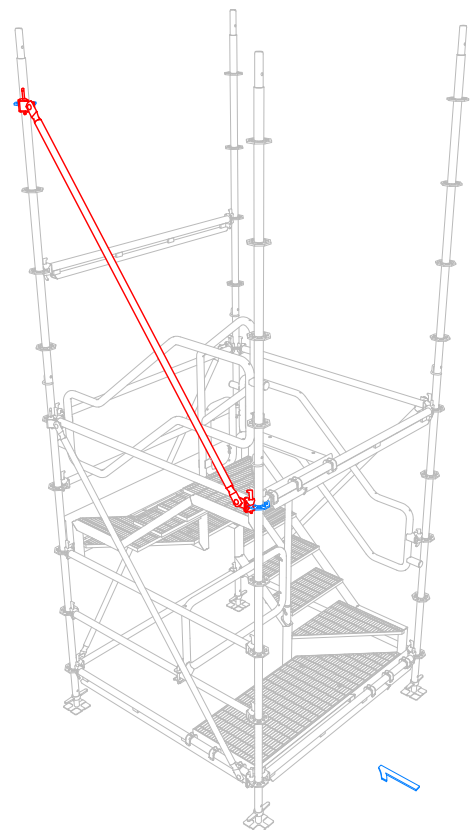
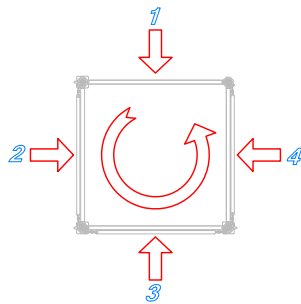
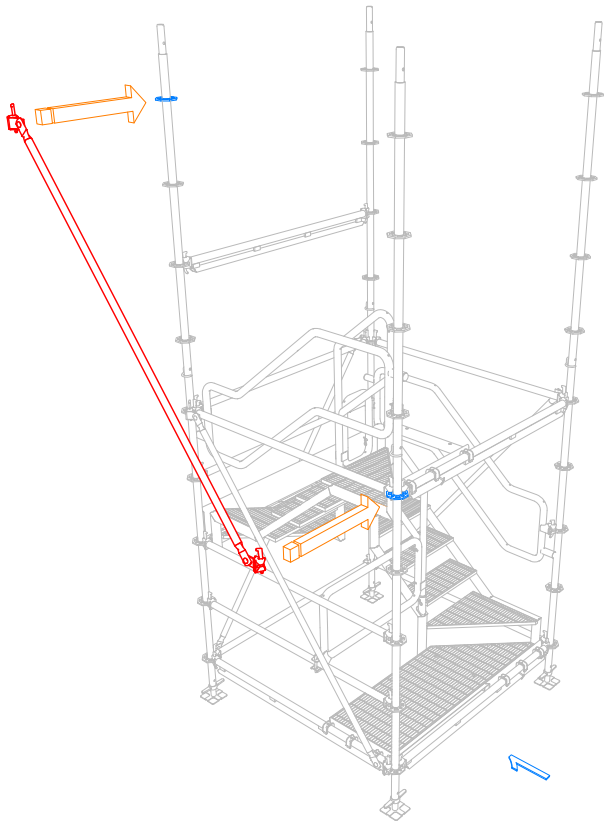

QUATTORDICESIMA FASE:
3150500121 SM8 DIAGONALE VISTA 1800X2000 MM Z.C.

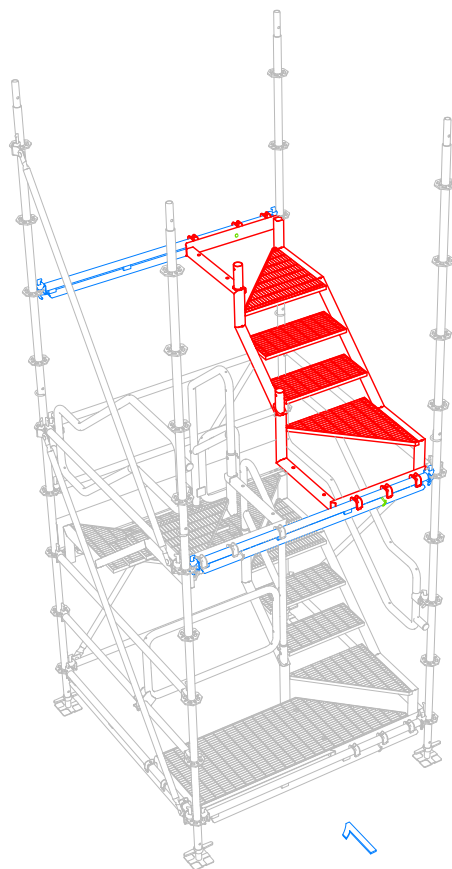
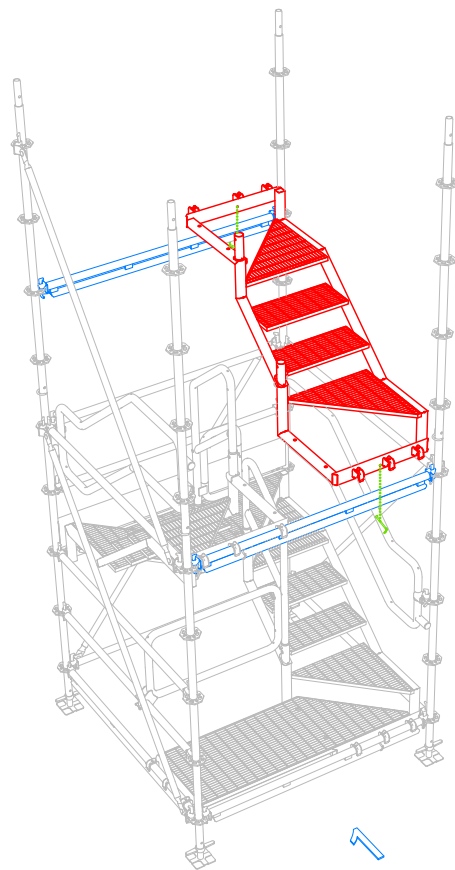
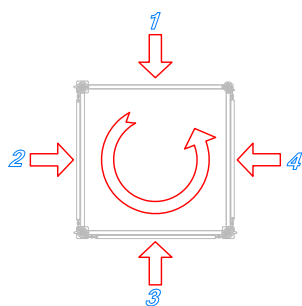
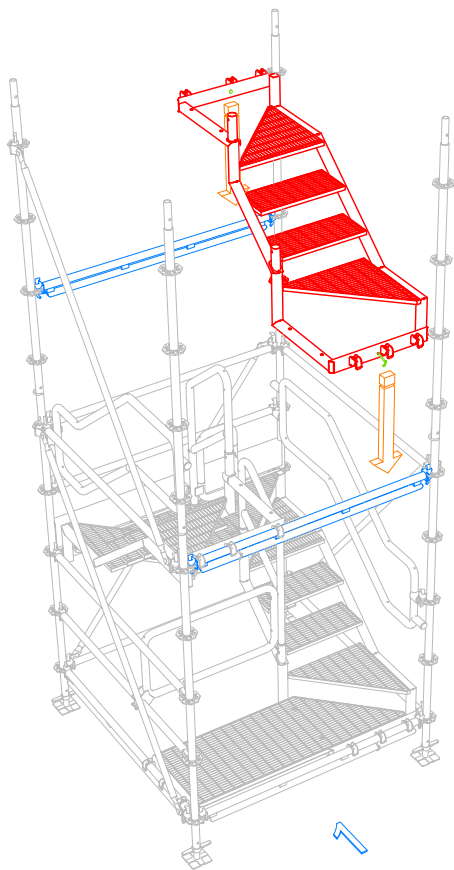

QUINDICESIMA FASE:
SM8 SCALA 1800X1800 RAMPA SCALA Z.C.

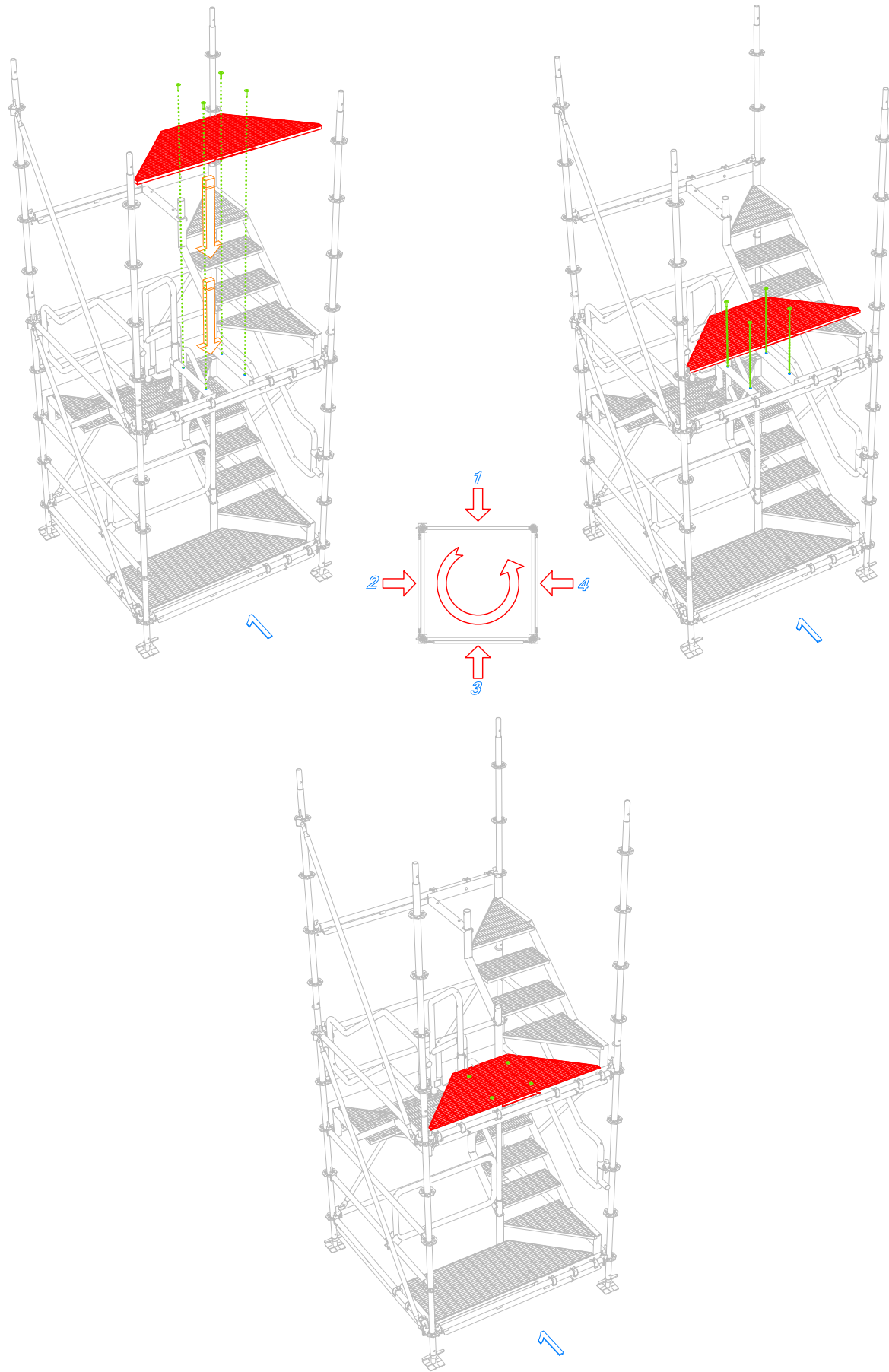

SEDICESIMA FASE:
SM8 SCALA 1800X1800 SBARCO INTERME. Z.C.

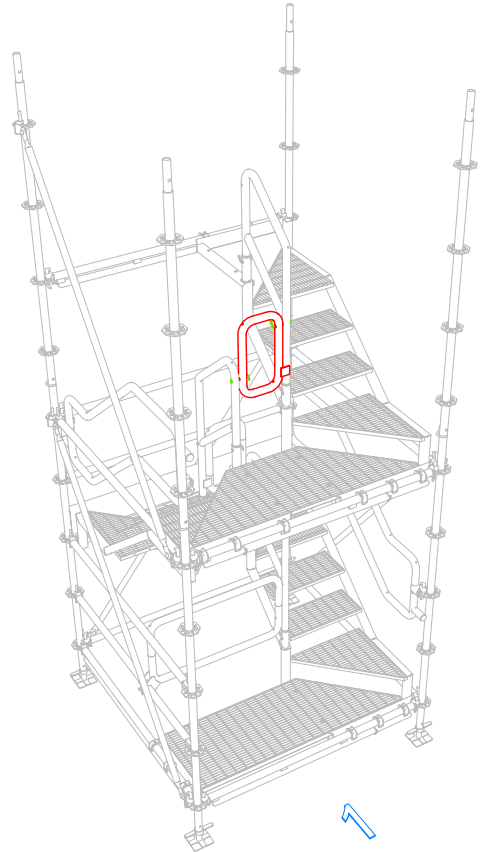
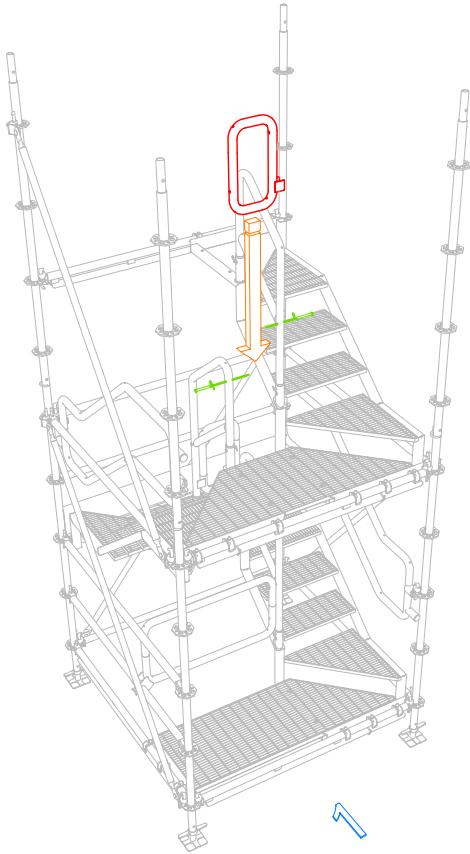
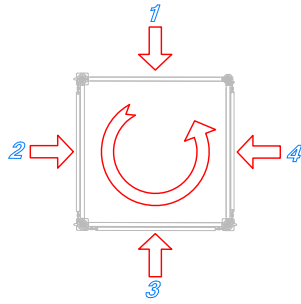

DICIASSETESIMA FASE
SM8 SCALA 1800X1800 RACCORDO PARAP.INT. Z.C.